

# MATERIAL HANDLING EQUIPMENT

## Catalogue

EDITION 07



PALLET TRUCKS, STACKERS, PLATFORM TROLLEYS, LIFTERS,  
SACK TRUCKS, ACCESS PLATFORMS, SKID LIFTERS, ELECTRIC  
HIGH LIFT PALLET TRUCKS, SCISSOR LIFT TABLES, HYDRAULIC  
MAGLINER HAND TRUCKS, PALLET TILTERS, SKATES, MANUAL  
WORKSHOP CRANES, POWERED STACKERS, MINI LIFTERS,  
WHEELS, ROUGH TERRAIN TRUCKS, ELECTRIC STACKERS,  
POWERED PALLET TRUCKS, FURNITURE MOVERS, JACKS, S

Over 100 material handling products inside

# Standard Hand Pallet Truck

- Designed for everyday heavy duty use
- Nylon steer wheels and load rollers as standard
- Polyurethane, rubber and steel wheels also available



**2500kg Capacity**

Comfortable ergonomic handle with rubberised plastic grip.



MODEL	CAPACITY (kg)	WIDTH OVER FORKS (mm)	FORK LENGTH (mm)	LOWERED HEIGHT	RAISED HEIGHT	PRICE
MA25-540x1150	2500	540	1150	85 mm	200 mm	£359.00

# LiftMate Standard Weighing Pallet Trucks

- Generous 2200kg capacity • Designed and built in Europe • Very robust and accurate 0.1% accuracy • 500g increments • Rubber steer wheels & tandem polyurethane rollers

MODEL	WIDTH OVER FORKS (mm)	FORK LENGTH (mm)	LOWERED HEIGHT	RAISED HEIGHT	PRICE
LM/WS/560x1150	560	1150	85 mm	205 mm	£1,395.00
LM/WS/560x1150-75	560	1150	75 mm	190 mm	£1,595.00
LM/WS/695x1000-75	695	1000	75 mm	190 mm	£1,795.00
LM/WS/695x1150-75	695	1150	75 mm	190 mm	£1,795.00
Optional Thermal Printer					£345.00



Optional Thermal Printer

**from £1,395.00 only**



LM/WS 560x1150



LM/WS 695x1150

# Contents

Pallet Trucks 2 - 17

Stackers & Lifters 18 - 31

High Lift Pallet Trucks 32

Skid Lifters 33

Pallet Tilters 33

Scissor Lift Tables 34 - 37

Jacks 38 - 39

Skates 40 - 43

Furniture Movers 44

Workshop Cranes 45

Misc. Cranes 45

Platform Trolleys 46 - 49

Sack Trucks 50 - 57

Magliner Hand Trucks 60 - 72

Wheels 73 - 80

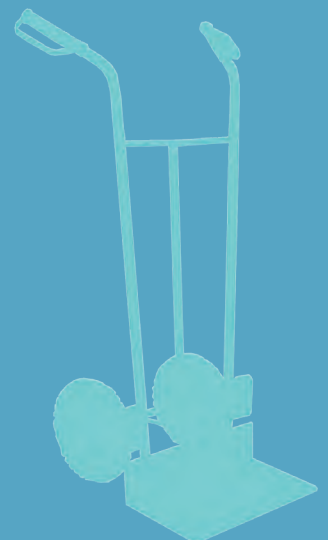
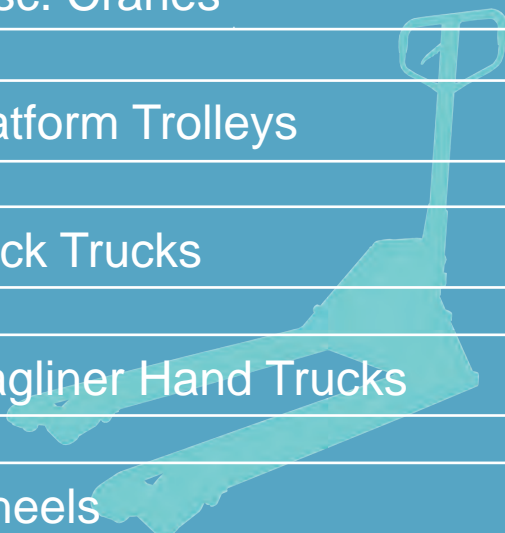
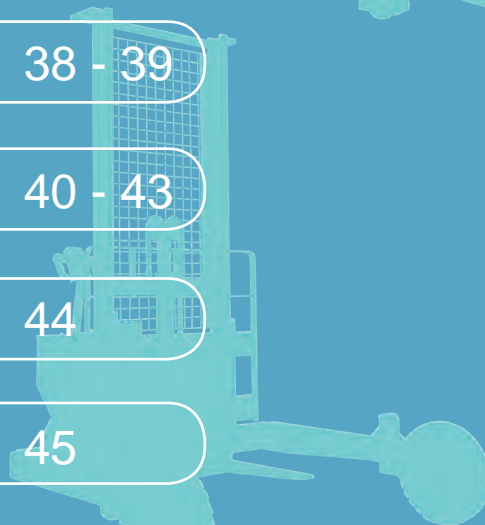
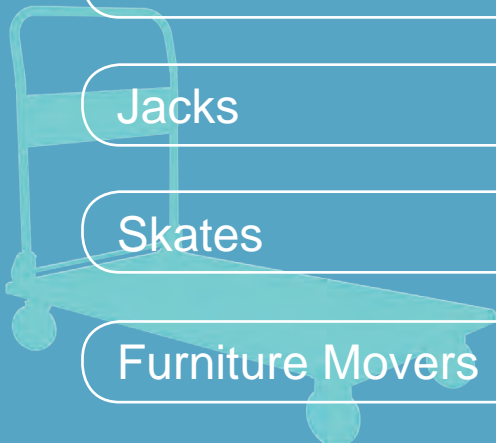
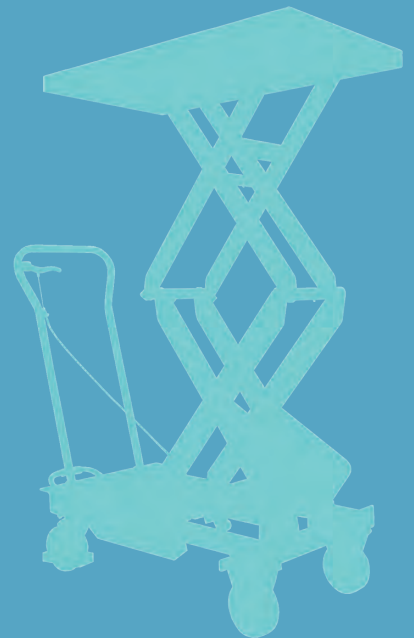



## Heavy Duty Pallet Trucks

- Designed for everyday heavy duty use
- 2500 kg capacity
- Lift height: 85 - 200 mm
- Nylon steer wheels and load wheels as standard
- Polyurethane, rubber and steel wheels available
- Wet spec and cold store spec available

FORK LENGTH (mm)	WIDTH OVER FORKS (mm)	ORDER REF	PRICE
800	540	MA25-540x800	£359.00
1000	540	MA25-540x1000	£359.00
1150	540	MA25-540x1150	£359.00
1220	540	MA25-540x1220	£369.00
1000	680	MA25-680x1000	£389.00
1150	680	MA25-680x1150	£389.00
1220	680	MA25-680x1220	£399.00



## Extra Long Pallet Trucks

- 2000, 2500 & 3500 kg Capacity
- Lift height: 85 - 200 mm
- Designed with extra-long forks to handle extra-long pallets
- Nylon steer and load wheels as standard for MA20 models
- Polyurethane steer and load wheels as standard for PT25 & PT35
- Polyurethane, rubber and steel wheels also available for MA20

CAPACITY (kg)	FORK LENGTH (mm)	WIDTH OVER FORKS (mm)	ORDER REF	PRICE
2000	1500	540	MA20-540x1500	£595.00
2000	1800	540	MA20-540x1800	£695.00
2000	2000	540	MA20-540x2000	£795.00
2000	1500	680	MA20-680x1500	£695.00
2000	1800	680	MA20-680x1800	£795.00
2000	2000	680	MA20-680x2000	£895.00
2500	2000	520	PT25-520x2000	£1,195.00
2500	2000	680	PT25-680x2000	£1,195.00
3500	2000	520	PT35-520x2000	£1,495.00
3500	2000	680	PT35-680x2000	£1,495.00
3500	2500	540	MA35-540x2500	£1,795.00
3500	2500	680	MA35-680x2500	£1,895.00



Dead Man Brake



Hand Brake



Foot Brake



## MA20 & MA25 Pallet Truck Options

DESCRIPTION	ORDER REF	PRICE
Polyurethane Steer Wheels	PU	£26.00
Rubber Steer Wheels	RU	£22.00
Steel Steer Wheels	ST	£190.00
Nylon Tandem Load Rollers	TN	£28.00
Polyurethane Single Load Rollers	SPU	£20.00
Polyurethane Tandem Load Rollers	TPU	£38.00
Rubber Single Load Rollers	SRU	£22.00
Rubber Tandem Load Rollers	TRU	£38.00
Steel Single Load Rollers	SST	£60.00
Steel Tandem Load Rollers	TST	£110.00
Parking Foot Brake	PFB	£78.00
Travel and Parking Hand Brake	THB	£190.00
Dead Man Brake	DMB	£540.00
Quick Lift Pump	QL	£90.00
Antistatic Polyurethane Steer Wheels	ASPU	£196.00
Antistatic Polyurethane Single Load Rollers	SASPU	£68.00
Antistatic Polyurethane Tandem Load Rollers	TASPU	£144.00

Nylon Steer wheels and Single Nylon Load rollers are fitted as standard

## Short & Narrow (Printer's) Pallet Trucks

- 2500 kg Capacity
- Heavy duty and robust built pallet trucks
- Ideal for use with narrow or half size pallets
- Commonly used in the printing industry
- 3 position lever
- Ergonomic handle fitted with a comfortable plastic cover
- Fingertip operated controlled lowering valve
- All wheels are fitted with sealed ball bearings
- 460mm wide trucks (with 800mm or longer forks) can handle Euro pallets
- Other wheels available on request



WIDTH OVER FORKS (mm)	FORK LENGTH (mm)	LIFT-HEIGHT (mm)	SINGLE FORK SIZE (mm)	WHEELS (STEER / ROLLERS)	ORDER REF	PRICE
460	500	80 - 200	150	Polyurethane	PT25-460x500	£595.00
460	600	80 - 200	150	Polyurethane	PT25-460x600	£595.00
460	800	80 - 200	150	Polyurethane	PT25-460x800	£595.00
460	900	80 - 200	150	Polyurethane	PT25-460x900	£595.00
460	1000	80 - 200	150	Polyurethane	PT25-460x1000	£595.00
460	1150	80 - 200	150	Polyurethane	PT25-460x1150	£595.00
460	1200	80 - 200	150	Polyurethane	PT25-460x1200	£595.00
520	500	80 - 200	150	Polyurethane	PT25-520x500	£595.00
520	600	80 - 200	150	Polyurethane	PT25-520x600	£595.00
520	800	80 - 200	150	Polyurethane	PT25-520x800	£595.00
520	900	80 - 200	150	Polyurethane	PT25-520x900	£595.00
450	900	75 - 190	160	Nylon	MA25-450x900	£435.00
450	1000	75 - 190	160	Nylon	MA25-450x1000	£435.00



PT25-460x1150



PT25-520x600

### PALLET TRUCK OPTIONS FOR PT25 MODELS

DESCRIPTION	ORDER REF	PRICE
Nylon Steer Wheels	N	FOC
Nylon Single Load Rollers	SN	FOC
Nylon Tandem Load Rollers	TN	£36.00
Polyurethane Tandem Load Rollers	TPU	£36.00
Rubber Steer Wheels	RU	£26.00

Polyurethane Steer wheels & Single Load rollers are fitted as standard

## Pallet Truck Chocks

- Secures pallet trucks in place in a moving truck or trailer
- Prevents damage to pallet trucks
- Eliminates freight and trailer damage
- Eliminates the need to turn pallet trucks sideways during transit
- Easy storage

LENGTH (mm)	WIDTH (mm)	ORDER REF	PRICE
270	320	CH3	£19.99
365	295	CH2	£35.00
355	645	CH1	£70.00

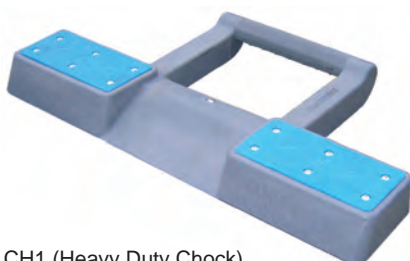

CH1 (Heavy Duty Chock)



CH2 (Basic Chock)



CH3 (Compact Chock)





## Mini Hand Pallet Truck

- 500 kg Capacity
- Weight: 35 kg
- Designed for small pallets (not suitable for standard pallets)
- Highly manoeuvrable, turning radius 700 - 800mm
- Polyurethane steer wheels and single nylon load wheels
- Lift height: 60 - 170 mm

FORK LENGTH (mm)	WIDTH OVER FORKS (mm)	SINGLE FORK WIDTH (mm)	ORDER REF	PRICE
800	380	100	LLT500	£299.00

Optional Polyurethane Load Rollers				£40.00
------------------------------------	--	--	--	--------

## Semi Low Profile Pallet Trucks (MA25/75)

- Designed for handling lower pallets or stillages where a standard truck will not fit
- Popular for use with US Pallets
- 2500 kg capacity
- Lift height: 75 - 190 mm
- Nylon steer and single nylon load wheels as standard
- Polyurethane and rubber wheels available on request

MA25/75-680x1150



FORK LENGTH (mm)	WIDTH OVER FORKS (mm)	ORDER REF	PRICE
900	450	MA25/75-450x900	£435.00
1000	450	MA25/75-450x1000	£435.00
1000	540	MA25/75-540x1000	£435.00
1150	540	MA25/75-540x1150	£435.00
1220	540	MA25/75-540x1220	£435.00
1000	680	MA25/75-680x1000	£455.00
1150	680	MA25/75-680x1150	£455.00
1220	680	MA25/75-680x1220	£455.00

## Low Profile Pallet Trucks (MA15/51)

- Designed for handling low pallets or stillages where a standard truck will not fit
- 1500 kg capacity
- Lift height: 51 - 170 mm
- Polyurethane steer and tandem load wheels as standard
- Nylon wheels available on request

MA15/51-540x1150



FORK LENGTH (mm)	WIDTH OVER FORKS (mm)	ORDER REF	PRICE
1000	540	MA15/51-540x1000	£555.00
1150	540	MA15/51-540x1150	£555.00
1220	540	MA15/51-540x1220	£555.00
1000	680	MA15/51-680x1000	£585.00
1150	680	MA15/51-680x1150	£585.00
1220	680	MA15/51-680x1220	£585.00

## Extra Low Profile Pallet Trucks (MA10/35)

- Designed for handling very low pallets or stillages where a standard or even a low profile truck will not fit
- 1000 kg capacity
- Lift height: 35 - 96 mm
- Polyurethane or nylon steer wheels and steel load wheels

MA10/35-530x1120

MA10/35-838x1120



FORK LENGTH (mm)	WIDTH OVER FORKS (mm)	ORDER REF	PRICE
1120	530	MA10/35-530x1120	£885.00
1120	680	MA10/35-680x1120	£885.00
1120	838	MA10/35-838x1120	£885.00

### Adjustable Pallet Trucks (PTA22)

- Highly versatile
- Can be adjusted to suit different pallet sizes
- 2200 kg capacity
- Lift height: 76 - 196 mm
- Durable easy rolling polyurethane wheels
- High quality hydraulic pump with controlled lowering
- Ergonomic comfortable steer handle

FORK LENGTH (mm)	WIDTH OVER FORKS (mm)	ORDER REF	PRICE
900	400-520	PTA22MS	£525.00
1050	400-520	PTA22M	£535.00
1150	400-520	PTA22ML	£545.00
900	530-680	PTA22LS	£535.00
1050	530-680	PTA22LM	£545.00
1150	530-680	PTA22L	£555.00
Tandem Load Roller Assembly			£36.00

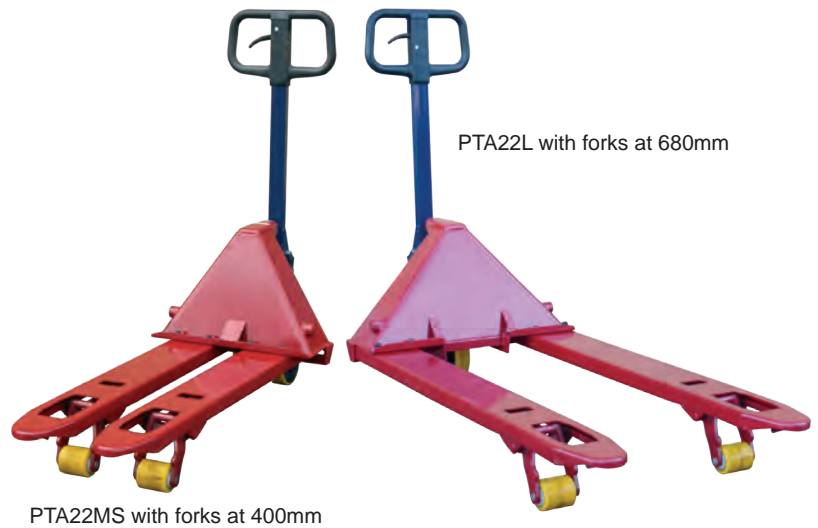

### Very Heavy Duty Pallet Trucks

- Designed for very heavy duty use
- 3000 & 3500 kg capacity
- Lift height: 85 - 200 mm (75mm lowered height available)
- Polyurethane steer and tandem load wheels as standard

CAPACITY (kg)	FORK LENGTH (mm)	WIDTH OVER FORKS (mm)	ORDER REF	PRICE
3000	1150	540	MA30-540x1150	£475.00
3000	1220	540	MA30-540x1220	£475.00
3000	1150	680	MA30-680x1150	£475.00
3000	1220	680	MA30-680x1220	£475.00
3500	1150	540	MA35-540x1150	£695.00
3500	1220	680	MA35-680x1220	£795.00
3500	2000	520	PT35-520x2000	£1,495.00
3500	2000	680	PT35-680x2000	£1,495.00
3500	2500	540	MA35-540x2500	£1,795.00
3500	2500	680	MA35-680x2500	£1,895.00



MA35-540x2500



MA35-680x1220

MA30-540x1150

### Very Heavy Duty Pallet Truck (MA50)

- 5000 kg capacity
- Designed for very heavy duty use
- Lift height: 90 - 200 mm
- Reinforced chassis
- Steel steer wheels and steel tandem load wheels as standard

FORK LENGTH (mm)	WIDTH OVER FORKS (mm)	ORDER REF	PRICE
1150	580	MA50-580x1150	£1,295.00
1500	580	MA50-580x1500	£3,295.00
1800	580	MA50-580x1800	£3,495.00
2000	580	MA50-580x2000	£3,995.00
1150	680	MA50-680x1150	£1,345.00
1500	680	MA50-680x1500	£3,295.00
1800	680	MA50-680x1800	£3,495.00
2000	680	MA50-680x2000	£3,995.00

Optional Polyurethane Wheels	£500.00
Optional Foot Brake	£200.00



MA50-580x2000



Polyurethane Wheels & Foot Brake

MA50-580x1150

## Premium Hand Pallet Trucks

LLT models are made in Europe.

Any size can be made to order.

- 2300 kg capacity
- Lift height: 85 - 205 mm
- 'Anti-bump Roller' - for added protection against shock loads
- Rounded Fork Toes - simplifies and eases pallet entry
- Nylon steer wheels and single nylon load wheels as standard
- Please see below for other wheel options

Special versions of this model are available on request:

- Capacity: 3000 and 4000 kg
- Galvanised and Stainless steel models
- Reel handling pallet truck
- Special superstructures
- **Special sizes:**
- Widths from 160 to 3000 mm available
- Lengths from 500 to 3500 mm available



FORK LENGTH (mm)	WIDTH OVER FORKS 450 mm	
	ORDER REF	PRICE
500	LLT23-05-45	£745.00
600	LLT23-06-45	£745.00
650	LLT23-65-45	£745.00
700	LLT23-07-45	£745.00
750	LLT23-75-45	£745.00
800	LLT23-08-45	£745.00
900	LLT23-09-45	£745.00
1000	LLT23-10-45	£745.00
1150	LLT23-11-45	£745.00
1220	LLT23-12-45	£845.00
1500	LLT23-15-45	£945.00

FORK LENGTH (mm)	WIDTH OVER FORKS 520 mm	
	ORDER REF	PRICE
500	LLT23-05-52	£745.00
600	LLT23-06-52	£745.00
650	LLT23-65-52	£745.00
700	LLT23-07-52	£745.00
750	LLT23-75-52	£745.00
800	LLT23-08-52	£745.00
900	LLT23-09-52	£745.00
950	LLT23-95-52	£745.00
1000	LLT23-10-52	£745.00
1150	LLT23-11-52	£745.00
1220	LLT23-12-52	£845.00
1500	LLT23-15-52	£945.00
1800	LLT23-18-52	£1,175.00
2000	LLT23-20-52	£1,410.00
2300	LLT23-23-52	£1,645.00
2500	LLT23-25-52	£1,695.00
3000	LLT23-30-52	£2,220.00
3500	LLT23-35-52	£3,125.00

FORK LENGTH (mm)	WIDTH OVER FORKS 680 mm	
	ORDER REF	PRICE
500	LLT23-05-68	£795.00
600	LLT23-06-68	£795.00
650	LLT23-65-68	£795.00
700	LLT23-07-68	£795.00
750	LLT23-75-68	£795.00
800	LLT23-08-68	£795.00
900	LLT23-09-68	£795.00
950	LLT23-95-68	£795.00
1000	LLT23-10-68	£795.00
1150	LLT23-11-68	£795.00
1220	LLT23-12-68	£895.00
1500	LLT23-15-68	£945.00
1800	LLT23-18-68	£1,175.00
2000	LLT23-20-68	£1,410.00
2300	LLT23-23-68	£1,645.00
2500	LLT23-25-68	£1,695.00
3000	LLT23-30-68	£2,220.00
3500	LLT23-35-68	£3,125.00



### PALLET TRUCK OPTIONS FOR LLT23 MODELS

DESCRIPTION	ORDER REF	PRICE
Hand & Travel Brake	THB	£560.00
Dead-man Brake	DMB	£600.00
Foot Brake	LLTFB	£75.00
Polyurethane Steer Wheels	PU	£30.00
Rubber Steer Wheels	RU	£26.00
Steel Steer Wheels	ST	£180.00
Stabilising Castor Wheels	SCW	£275.00
Nylon Tandem Load Rollers	TN	£30.00
Polyurethane Single Load Rollers	SPU	£20.00
Polyurethane Tandem Load Rollers	TPU	£40.00
Rubber Single Load Rollers	SRU	£26.00
Rubber Tandem Load Rollers	TRU	£40.00
Steel Single Load Rollers	SST	£65.00
Steel Tandem Load Rollers	TST	£120.00

Nylon steer wheels and single nylon load rollers are fitted as standard



Foot Brake



Dead-man Brake



Hand & Travel Brake



### Heavy Duty Premium Hand Pallet Trucks (LLT30)

A premium quality, European designed and manufactured pallet truck. It can be provided from stock or made to order.

Please call for size preferences.

- 3000 kg capacity
- Lift height: 85 - 205 mm
- Length of forks: 500 - 3500 mm available
- Width over forks: 160 - 2000 mm available
- See 'Pallet Truck Options for LLT23' for wheel choices

**Prices start from: £995.00**



LLT30-840x1300

### Very Heavy Duty Premium Hand Pallet Trucks (LLT40)

A premium quality, European designed and manufactured pallet truck.

Please call for size preferences.

- 4000 kg capacity
- Lift height: 85 - 205 mm
- Length of forks: 500 - 2500 mm available
- Width over forks: 160 - 2000 mm available
- See 'Pallet Truck Options for LLT23' for wheel choices

**Prices start from: £2,395.00**



LLT40-900x1150

### Semi-Low Profile Pallet Trucks (LLT23/75)

The LLT23/75 is a semi-low profile version of the LLT23 hand pallet truck. It comes in all sizes and can be provided from stock or made to order. Please call for size preferences.

- 2300 kg capacity
- Lift height: 75 - 190 mm
- Length of forks: 500 - 2000 mm
- Width over forks: 500 - 1000 mm
- See 'Pallet Truck Options for LLT23' for wheel choices

**Prices start from: £845.00**



LLT23/75-700x1400

### Heavy Duty Low Profile Pallet Trucks (LLT23/51)

The LLT23/51 is a low profile version of the LLT23 hand pallet truck. It comes in all sizes and can be provided from stock or made to order. Please call for size preferences.

- 2300 kg capacity
- Lift height: 51 - 170 mm
- Length of forks: 500 - 3000 mm
- Width over forks: 160 - 2000 mm
- Polyurethane wheels as standard

**Prices start from: £1,185.00**



LLT23/51-680x1800

### 8 & 10 ton Very Heavy Duty Pallet Trucks

- Length of forks: 1220 - 2500 mm
- Width over forks: 550 - 1500 mm

**Prices start from: £2,500.00**



MA80-550x1800



MA100-685x1220



MA25G-680x1000

## Galvanised Pallet Trucks (MA25G)

- Hot dip galvanised or zinc plated pallet trucks
- Ideal for cold stores and outdoor applications
- 2500 kg capacity
- Lift height: 85 - 200 mm
- Nylon steer and tandem nylon load wheels as standard
- Wheels fitted with stainless steel bearings
- Other wheels available on request

FORK LENGTH (mm)	WIDTH OVER FORKS (mm)	ORDER REF	PRICE
1000	540	MA25G-540x1000	£699.00
1150	540	MA25G-540x1150	£699.00
1000	680	MA25G-680x1000	£749.00
1150	680	MA25G-680x1150	£749.00



## Low Profile Galvanised Pallet Trucks (LLT23/51G)

- Ideal for cold stores and outdoor applications
- 2300 kg or 3000 kg capacity
- Lift height: 85 - 205 mm or 51 - 170 mm
- Length of forks: 1000 or 1150 mm
- Width over forks: 520 or 680 mm
- Special fork lengths and widths available on request
- See 'Pallet Truck Options for LLT23' for wheel choices

**Prices start from: £1,485.00**



MA20S-540x1150

## Stainless Steel Pallet Trucks (MA20S)

- 100% Stainless
- Designed for environments where hygiene is paramount or where the pallet truck will come into contact with corrosive substances such as salt, water, acid or chemicals
- 2000 kg capacity
- Lift height: 85 - 200 mm
- AISI 304 as standard, AISI 316 available on request
- Nylon steer wheels and tandem nylon load wheels as standard
- Other wheels available on request
- Special sizes can be made to order

CAPACITY (kg)	FORK LENGTH (mm)	WIDTH OVER FORKS (mm)	ORDER REF	PRICE
2000	1000	540	MA20S-540x1000	£2,495.00
2000	1150	540	MA20S-540x1150	£2,495.00
2000	1000	680	MA20S-680x1000	£2,595.00
2000	1150	680	MA20S-680x1150	£2,595.00

## LIFTMATE WEIGHING PALLET TRUCKS

- LiftMate offer a wide range of weighing pallet trucks for every application in trade and industry
- All weighing trucks have a generous capacity of 2200kg (3000kg on special order) and are very accurate
- All models are designed and built in Europe to strict quality standards
- We can offer bespoke weighing pallet trucks to specific requirements
- Most models can be supplied in Sale by Weight version and with a choice of printers

### LiftMate Standard Weighing Pallet Trucks

- 2200kg capacity
- 500g increments
- 0.1% accuracy
- Lift height: 75 - 190mm (LM/WS/560x1150: 85 - 205mm)
- Rubber steer wheels and tandem polyurethane load wheels
- Weighing trucks can be supplied with various optional printers

FORK LENGTH (mm)	WIDTH OVER FORKS (mm)	ORDER REF	PRICE
1150	560	LM/WS/560x1150	£1,395.00
1150	560	LM/WS/560x1150-75	£1,595.00
1000	695	LM/WS/695x1000-75	£1,795.00
1150	695	LM/WS/695x1150-75	£1,795.00

Optional standard Thermal Printer			£345.00
-----------------------------------	--	--	---------



LM/WS/560x1150

### LiftMate Premium Weighing Pallet Trucks

- Approved for Sale by Weight, Class III accuracy
- 2200kg capacity
- 200g, 500g or 1000g increments
- 0.02% accuracy
- Lift height: 85 - 205mm (75 - 190mm for 695mm width over forks)
- Rubber steer wheels and tandem polyurethane load wheels

FORK LENGTH (mm)	WIDTH OVER FORKS (mm)	ORDER REF	PRICE
1150	560	LM/WSP/560x1150	£1,795.00
1150	695	LM/WSP/695x1150	£1,995.00



LM/WSP/560x1150

### LiftMate Stainless Steel Weighing Pallet Trucks

- Ideal for the food & pharmaceutical industries
- 2200kg capacity
- Made from high grade 304 stainless steel
- 500g standard increments
- 0.05% accuracy
- Optional Sale by Weight version and Class III accuracy
- Lift height: 85 - 205mm (75 - 190mm for 695mm width over forks)
- Rubber steer wheels and tandem polyurethane load wheels
- Standard indicator has IP 67 protection

FORK LENGTH (mm)	WIDTH OVER FORKS (mm)	ORDER REF	PRICE
1150	560	LM/WSSS/560x1150	£5,495.00
1150	695	LM/WSSS/695x1150	£5,995.00



LM/WSSS/560x1150

### LiftMate ATEX Weighing Pallet Trucks

- Based on the robust & accurate Premium model
- Lift height: 85 - 205mm (75 - 190mm for 695mm width over forks)
- Stainless steel cladding on forks & display housing, anti-static wheels, approved indicators
- Made from high grade 304 stainless steel
- 0.05% accuracy, 500g increments
- Anti-static wheels and tandem polyurethane load wheels

ATEX ZONE	FORK LENGTH (mm)	WIDTH OVER FORKS (mm)	ORDER REF	PRICE
Zone 1	1150	560	LM/WSEX/Z1	£4,995.00
Zone 2	1150	560	LM/WSEX/Z2	£3,995.00



LM/WSEX/Z1

## Higher Lift Pallet Trucks (LLT20/280)

The Higher Lift Pallet Truck can be raised up to 280 mm. It is available in various fork sizes. Please call for more information.

- 2000 kg capacity
- Lift height: 85 - 280 mm
- Length of forks: 800 - 2000 mm
- Width over forks: 520 - 1000 mm
- See 'Pallet Truck Options for LLT23' for wheel choices

Prices start from: £1,395.00



LLT20/280-1540x2000



LLT20/280-520x1150

## 4-Way Hand Pallet Truck (MA15/4W)

- Four way directional movement: forward and backward; side to side
- 1500 kg Capacity
- Lift height: 85 - 205 mm
- Polyurethane, Nylon or Steel wheels
- Special sizes available

FORK LENGTH (mm)	WIDTH OVER FORKS (mm)	ORDER REF	PRICE
1150	540	MA15F	£549.00



## Heavy Duty 4 Way Directional Pallet Trucks (LLT23/4W)

Designed for 4 way - forward and backward; side to side - directional movement of pallet truck

- 2300 kg capacity
- Lift height: 85 - 205 mm
- All fork sizes available
- See 'Pallet Truck Options for LLT23' for wheel choices

Prices start from: £1,395.00



LLT23/4W-680x2000

### ATEX Pallet Trucks (LLT23/ATEX)

Ideal for use in paint and alcohol factories or offshore in potentially explosive atmospheres.

- 2000, 2300, 2500, 3000, 4000 and 5000 kg capacity
- Lift height: 85 - 205 mm
- Length of forks: 1000 or 1150 mm
- Width over forks: 520 or 680 mm
- Special fork lengths and widths available on request
- See 'Pallet Truck Options for LLT23' for wheel choices

Prices start from: £3,495.00



### Reel Carrying & Dispensing Pallet Trucks (LLT23BF)

Designed with angled forks suitable for handling rolls and reels. It can be manufactured for reels up to 2500 mm in diameter.

- 2300 kg or 3000 kg capacity
- Can be designed to handle 400 to 2500 mm diameter reels
- Length of forks: 600 - 2500 mm
- Width over forks: up to 1500 mm
- Inner flaps Option: Handles both very small and very large diameter reels
- See 'Pallet Truck Options for LLT23' for wheel choices

Prices start from: £1,585.00



Reel Dispensing Truck



Reel Carrying Truck  
With inner flaps



Reel Carrying Truck



Reel Dispensing Truck

# Rough Terrain Pallet Trucks

## Rough Terrain Pallet Trucks

- Transports loads on uneven ground
- Minimum maintenance required
- Great manoeuvrability
- Adjustable width over forks
- Wheels fitted onto sealed bearings
- Large diameter terrain wheels
- Galvanised version available



TNV500



TNV750



TNV1500S

### Optional Adjustable Fork Height (compatible with TNV1500S & TNN1500)



No. of Fork Height Levels	5
Distance between Levels	100mm
<b>TOP FORK LEVEL</b>	
Raised Height (front / back)	695 / 635mm
Lowered Height	455mm
<b>BOTTOM FORK LEVEL</b>	
Raised Height (front / back)	305 / 235mm
Lowered Height	ground
Price	£495.00

CAPACITY (kg)	LOAD CENTRE (mm)	FORK LENGTH (mm)	WIDTH OVER FORKS (mm)	MAX PALLET SIZE (mm)	OVERALL WIDTH (mm)	STRADDLE GAP (mm)	ORDER REF	PRICE
500	400	620	170 - 570	700 x 800	990	750	TNV500	£995.00
500	400	1100	220 - 560	800 x 1200	1090	850	TNV500-EURO	£1,395.00
500	400	1100	220 - 560	1000 x 1200	1290	1050	TNV500-GKN	£1,395.00
500	400	620	170 - 570	700 x 800	990	750	TNV500T-750	£995.00
500	400	620	170 - 570	800 x 800	1105	850	TNV500T-850	£995.00
750	500	800	340 - 650	1000 x 1200	1730	1300	TNV750	£1,195.00
1200	500	800	340 - 650	1000 x 1200	1730	1300	TNV1200	£1,395.00
1500	500	890	160 - 560	1200 x 1200	1640	1270	TNV1500S	£1,595.00

Optional Height Adjustable Forks for TNV1500S TNV1500/S-AF £495.00

Optional Removable Tow Bar for TNV1500S TNV1500/S-TB £595.00

Lowered height: 40mm, Raised height: 210 / 270 (TNV500 only)

## Mini Rough Terrain Tilt Pallet Truck

- This model has forks which tilt when raised
- Prevents the load from sliding off the forks
- The tilt is mechanical
- The fork tips go up thanks to an angled top part of the mast
- STRADDLE GAP: 750 or 850 mm
- See above table for specifications



TNV500T



## Optional Removable Tow Bar

- See above table for price



Available for TNV1500S and all TNNs

## Extra Wide Rough Terrain Pallet Truck

- Designed to handle oversized loads



TNW1200

## Narrow Rough Terrain Pallet Trucks

- Provides excellent manoeuvrability
- Fits through narrow gaps
- Optional hand brake available on TNN models



TNN1500

CAPACITY (kg)	LOAD CENTRE (mm)	FORK LENGTH (mm)	WIDTH OVER FORKS (mm)	MAX PALLET SIZE (mm)	O/A WIDTH (mm)	STRADDLE GAP (mm)	ORDER REF	PRICE
1200	400 - 600	700 - 1000	adjustable	-	-	up to 2500	TNW1200S	POA
1500	500	890	180 - 580	800 x 1200	1120	850	TNN1500/S-800	£1,895.00
1500	500	890	180 - 580	1000 x 1200	1320	1050	TNN1500/S-1000	£1,895.00
1500	500	890	180 - 580	1200 x 1200	1520	1250	TNN1500/S-1200	£1,895.00

							Braked Terrain Pallet Truck	TNN1500/S-1200B	£2,795.00
							Optional Height Adjustable Forks for TNN1500	TNN1500-AF	£395.00
							Optional Removable Tow Bar for TNN1500	TNN1500-TB	£595.00

## Special Rough Terrain Pallet Trucks



TNW Extra Wide Rough Terrain Pallet Truck with Reinforced Chassis



TNV500 with Tall Load Support & Strap



TNV1500S with Offshore Paint and 600mm Load Centre



TNV500 Extra Narrow Rough Terrain Truck

# Rough Terrain Pallet Trucks

## Electric Rough Terrain Pallet Truck

- Electric lift and drive
- Built-in charger
- 2 heavy duty batteries for full day operation
- Great manoeuvrability
- Adjustable width over forks
- Wheels fitted onto sealed bearings
- Pneumatic tyres
- Special sizes can be offered
- 240V charger - standard, included



TNE1200

CAPACITY (kg)	LOAD CENTRE (mm)	FORK LENGTH	WIDTH OVER FORKS (mm)	MAX PALLET SIZE (mm)	DRIVE WHEEL MOTOR (S)	BATTERY	STRADDLE GAP (mm)	ORDER REF	PRICE
1200	500	890 mm	160 - 560	1200 x 1200	1 x 500 DC	2 x 60A	1250	TNE1200 1DC	£8,995.00
1200	500	890 mm	160 - 560	1200 x 1200	1 x 1000 AC	2 x 100A	1250	TNE1200 1AC	£9,995.00
1200	500	890 mm	160 - 560	1200 x 1200	2 x 500 DC	2 x 100A	1250	TNE1200 2DC	£10,995.00
1500	500	1000 mm	160 - 900	1200 x 1200	1 x 2500 AC	2 x 100A	1266	TNE1500 AC	£12,995.00
Optional 110V Charger									£70.00

GRADIENT	TNE1200 1DC	TNE1200 1AC	TNE1200 2DC	TNE1500 AC
0%	1200kg	1200kg	1200kg	1500kg
1%	1200kg	1200kg	1200kg	1500kg
3%		1200kg	1200kg	1500kg
4%	800kg		1200kg	1500kg
5%			1200kg	1500kg
6%		800kg	1200kg	1500kg
8%	500kg		1200kg	1500kg
10%		500kg	1200kg	1500kg
14%	300kg			1500kg
15%			800kg	1500kg
18%		300kg		1500kg
20%	0kg			
23%			500kg	1200kg
25%		0kg		
30%			300kg	800kg
40%				500kg
45%			0kg	
50%				300kg
60%				0kg



TNE1200 with load

## Special Electric Rough Terrain Pallet Trucks



Extra Wide Electric Rough Terrain Pallet Truck



TNE with Tall Load Support and Load Strap



Narrow Electric Rough Terrain Pallet Truck



High Visibility Electric Rough Terrain Pallet Truck



## Electric Rough Terrain Pallet Stackers

- Raised chassis makes it ideal for rough terrains
- Can travel steep inclines of up to 10% with full load and 15% with 600kg
- Wide straddle legs provide great stability
- Adjustable forks fitted to a standard FEM CIIA carriage
- Large rough terrain wheels
- 2 independently powered drive wheels
- Ingress Protection Rating: IP54
- Special versions and attachments are available
- 240V charger - standard, included



RTS 12.16



RTS 12.25



CAPACITY (kg)	LIFT HEIGHT (mm)	LOAD CENTRE (mm)	FORK LENGTH (mm)	MAX PALLET SIZE (mm)	BATTERY	STRADDLE GAP (mm)	ORDER REF	PRICE
1000	1600	500	1100	1200 x 1000	2x12V / 100Ah	1260	RTS 10.16	£10,995.00
1000	2500	500	1100	1200 x 1000	2x12V / 100Ah	1260	RTS 10.25	£12,495.00
1000	3000	500	1100	1200 x 1000	2x12V / 100Ah	1260	RTS 10.30	£12,995.00
1200	1600	500	1100	1200 x 1000	2x12V / 100Ah	1260	RTS 12.16	£12,995.00
1200	2500	500	1100	1200 x 1000	2x12V / 100Ah	1260	RTS 12.25	£14,495.00
1200	3000	500	1100	1200 x 1000	2x12V / 100Ah	1260	RTS 12.30	£14,995.00
1500	1600	500	1100	1200 x 1000	2x12V / 100Ah	1260	RTS 15.16	£15,995.00
1500	2500	500	1100	1200 x 1000	2x12V / 100Ah	1260	RTS 15.25	£17,495.00
1500	3000	500	1100	1200 x 1000	2x12V / 100Ah	1260	RTS 15.30	£17,995.00

RTS 12 Fork Extensions, 1800mm (pair)	RTSA/FE1800	£545.00
RTS 12 Slide-On Crane Hook	RTSA/HOOK	£425.00
Optional 110V Charger		£70.00



Self Loading Version POA



Fork Extensions



Slide-On Crane Hook

## 2000kg Semi Powered Pallet Trucks

- Manual lift / Electric drive
- Easy to operate, strong yet compact pallet trucks
- Ergonomically designed handle with LED battery indicator
- Reversing button & accelerator control on handle
- Forks designed for easy pallet entry
- Portable and easily removable lithium battery
- Quick charging 2 - 5 hours
- Minimum maintenance
- 240V charger - standard, included (Optional 110V charger available)

CAPACITY (kg)	FORK LENGTH (mm)	WIDTH OVER FORKS (mm)	ORDER REF	PRICE
2000	1000	550	LEMP20S/550x1000	£1,595.00
2000	1150	550	LEMP20S/550x1150	£1,595.00
2000	1000	680	LEMP20S/680x1000	£1,595.00
Optional Spare Battery				£395.00
Optional 110V Charger				£70.00
Optional Handle Rain Cover				£59.00



LEMP20S 550x1150



LEPT20S 550x1150



LEMP20S



LEPT20S

Handle Rain Cover

## 2000kg Fully Powered Pallet Trucks

- Electric lift and Electric drive
- Easy to operate, strong yet compact pallet trucks
- Ergonomically designed handle with LED battery indicator
- Reversing button & accelerator control on handle
- Forks designed for easy pallet entry
- Portable and easily removable lithium battery
- Quick charging 2 - 5 hours
- Minimum maintenance
- 240V charger - standard, included (Optional 110V charger available)

CAPACITY (kg)	FORK LENGTH (mm)	WIDTH OVER FORKS (mm)	ORDER REF	PRICE
2000	1000	550	LEPT20S/550x1000	£1,895.00
2000	1150	550	LEPT20S/550x1150	£1,895.00
2000	1000	680	LEPT20S/680x1000	£1,895.00
2000	1220	680	LEPT20S/680x1220	£1,895.00
Optional Spare Battery				£395.00
Optional 110V Charger				£70.00
Optional Handle Rain Cover				£59.00



### 65mm Low Profile Fully Powered Pallet Trucks

- 65mm LOWERED FORK HEIGHT
- Electric lift and Electric drive
- See LEPT20S Fully Powered Pallet Trucks at bottom of page 16

CAPACITY (kg)	FORK LENGTH (mm)	WIDTH OVER FORKS (mm)	ORDER REF	PRICE
1500	1150	550	LEPT15S/550x1150-65L	£2,195.00
1500	1220	680	LEPT15S/680x1220-65L	£2,295.00
Optional Spare Battery				£395.00
Optional 110V Charger				£70.00
Optional Handle Rain Cover				£59.00



LEPT15S/680x1220-65L



65mm Lowered Fork Height



LEPT15S/550x1150-65L

### 1500 & 2000kg Medium Duty Electric Pallet Trucks

- Compact design
- Designed for light to medium duty applications
- Light enough for use on mezzanine floors and tail lifts
- 2 - 3 hours battery life • Integral charger
- Maintenance free batteries
- Rechargeable from any standard wall socket

CAPACITY (kg)	FORK SIZE (mm)	BATTERY	ORDER REF	PRICE
1500	520 x 1000	24V / 80Ah	LEPT15N/520x1000	£3,295.00
1500	520 x 1150	24V / 80Ah	LEPT15N/520x1150	£3,295.00
1500	680 x 1000	24V / 80Ah	LEPT15N/680x1000	£3,295.00
1500	680 x 1150	24V / 80Ah	LEPT15N/680x1150	£3,295.00
2000	520 x 1150	24V / 80Ah	LEPT20N/520x1150	£3,995.00
Optional 110V Charger				£70.00
3000	560 x 1150	24V / 250Ah	LiTP30/560x1150	£12,495.00



LEPT20N 520x1150

LEPT15N 520x1000

### 2000 & 3000kg Heavy Duty Powered Pallet Trucks

- 2000 & 3000 kg Capacity • Lift height: 90 - 200 mm
- Designed for carrying heavy weights on a regular basis
- Battery discharge indicator • Operating hours meter
- Optional rider platform

Prices start from: POA, (see table above for 3000kg model)



LiTP30-560x1150

### Very Heavy Duty Powered Pallet Trucks

5000, 7000, 8000, 10000, 12000 & 15000 kg Capacities

Prices start from: POA



LiTP80-690x1500

8000kg



LiTP70-1025x1500

7000kg

For examples of special models of Powered Pallet Trucks see page 30

## Mini Stacker (PML120N)

- Lightweight design
- Very easy to operate
- Suitable for supermarkets, offices, warehouses, narrow areas etc
- Platform size: 585 x 390 mm
- Load centre: 150 mm
- Weight: 25kg

CAPACITY (kg)	MAX LIFT HEIGHT (mm)	LIFT	ORDER REF	PRICE
120	1090	Manual	PML120N	£495.00

## Winch Lifter (WSB150)

- Doubles as a sack truck
- Removable extension mast
- The base has 4 ball bearings for short horizontal movement
- Optional removable platform
- Weight: 37kg

CAPACITY (kg)	MAX LIFT HEIGHT (mm)	LIFT	ORDER REF	PRICE
150	1070/1700	Manual	WSB150	£845.00

### OPTIONS

Optional Platform - 350 x 450mm	WSB150/PL	£95.00
Optional V-Platform attachment	WSB150/VPL	£95.00
Optional Cradle attachment	WSB150/Cradle	£195.00
Optional Loading Wheels	WSB150/LW	£350.00

Weight: only 37kg



WSB150 V-Platform attachment  
For rolls and reels



WSB150 Cradle attachment  
For water tanks

WSB150 with Loading Wheels Accessory



Loading Wheels Folded



Loading Wheels Unfolded

## Mini Stacker (MCH150)

- Choice of 2 frames: Zinc-plated steel or Stainless steel AISI 304 L
- Zinc-plated steel self-braked winch (available in stainless steel)
- Ø 4mm galvanised steel cable
- Swivel back wheels with brake
- Fork Length: 455mm / Width over Forks: 350mm
- Dimensions (L x W x H): 890 x 455 x 1650 mm
- Weight: 30kg
- Optional platforms: Please see WSB150/PL & WSB150/VPL above



Optional Platform

CAPACITY (kg)	FRAME TYPE	MAX LIFT HEIGHT (mm)	LIFT	ORDER REF	PRICE
150	Zinc-plated steel	55 - 1400	Manual	MCH150	£995.00
150	Stainless steel	55 - 1400	Manual	MCH150SS	£2,795.00



### Manual Winch Lifter (M200)

- Lightweight and compact design
- Versatile and easy to operate
- Comes with platform and forks as standard
- Supplied with non-marking swivel castor wheels
- Fitted with two foot brakes
- Other attachments available - see below

CAPACITY (kg)	MAX LIFT HEIGHT (mm)	LIFT	ORDER REF	PRICE
200	1500	Manual	M200	£745.00

Accessory price surcharge assumes the standard platform is not required and not supplied. If you require both the accessory and the standard platform please contact us. Ball Transfer Unit EP01 and V-Block EP03 are the exceptions as both require the platform to work so the platform is supplied with these two accessories.



### Electric Mini Lifters & Counterbalanced Lifter

- Electric motor
- Electric overload protection
- Portable hand control unit on a cable
- Automatic battery charger
- Maintenance free batteries
- Comes with platform and forks as standard
- Other attachments available

CAPACITY (kg)	MAX LIFT HEIGHT (mm)	LIFT	ORDER REF	PRICE
100	1500	Electric	E100R(B)*	£1,595.00
100	1700	Electric	E100**	£1,445.00
150	1500	Electric	E150**	£1,545.00
250	1905	Electric	E250*	£1,795.00
300	1500	Electric	E300 *	£1,845.00

\* 2 swivel castors / 2 fixed front castors

\*\* 4 swivel castors

MODEL	BATTERY V/Ah
E100R(B)	24/12
E100	24/12
E150	24/12
E250	24/20
E300	24/20



200mm Raised Frame  
£195.00

### Attachments for M200, E100R(B) & E100 - E300



Ball Transfer Unit - EP01  
610 x 480mm  
Capacity: 150kg  
£415.00



Roller Platform - EP02 / EP02S  
500 x 420mm  
Capacity: 150kg  
£300.00 / £400.00 (with stops)



V Block - EP03  
Capacity: 250kg  
£75.00



Single Boom Spindle - EP05  
ø 50 x 600mm  
Capacity: 250kg  
£180.00



Double Spindle - EP06  
ø 50 x 500mm (260mm centres)  
Capacity: 250kg  
£195.00

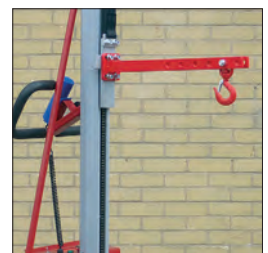

Jib and Hook - EP07  
500mm long  
Capacity: 150kg  
£195.00

## Manual Stackers (KI 400/1200A & KI 400/1500A)

- Adjustable forks
- Fork lengths: 600 mm
- Fork widths: 215 - 530 mm adjustable
- Ø 75 / Ø 125 mm polyurethane wheels
- Optional removable platform

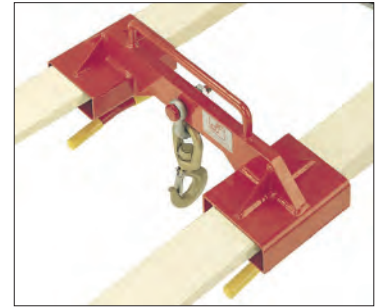

Optional Fork Mounted Hook



KI 400/1500A raised



KI 400/1500A



KI 400/1200A with Removable Platform

## Electric Stacker (KIE 400/1500A)

- Easy and fast lifting operation
- High quality hydraulic motor
- Service free battery
- Adjustable forks
- Fork length: 600 mm
- Fork width: 215 - 530 mm adjustable
- Ø 75 / Ø 125 mm polyurethane wheels
- Battery: 12V/60Ah
- Optional removable platform



KIE 400/1500A



with Straddle Legs option

CAPACITY (kg)	MAX LIFT HEIGHT (mm)	LOWERED FORK HEIGHT (mm)	OVERALL HEIGHT (mm)	LIFT	ORDER REF	PRICE
400	1200	85	1425	Manual	KI 400/1200A	£695.00
400	1500	85	1725	Manual	KI 400/1500A	£745.00
400	1500	85	1725	Electric	KIE 400/1500A	£1,895.00

### OPTIONS

Removable Platform - 575mm (W) x 650mm (D)	PL/KI/400	£65.00
Fork Mounted Hook	MDC-HOOK	£425.00

## 500kg Manual Pallet Stacker with Adjustable Forks

- 500kg capacity
- Robust construction
- Adjustable forks fitted as standard
- Swivel castor steer wheels
- Safety valve prevents overloading
- Adjustable lowering speed
- Special versions available: including attachments, galvanised and stainless steel finish and more

MAX LIFT HEIGHT (mm)	FORK LENGTH (mm)	WIDTH OVER FORKS (mm)	LIFT	ORDER REF	PRICE
1600	1100	220 - 760	Manual	KI 500/1600A	£1,095.00



KI 500/1600A Adjustable Forks



## 500kg Manual Lift Pallet Stackers

- Robust construction
- Ideally suited for safe handling of Euro-pallets
- 500kg capacity
- Load Centre: 600mm
- Fork length: 1150mm
- Width over forks: 545mm
- Lowered fork height: 85mm
- Straddle legs and adjustable forks available
- Bespoke versions available
- Special attachments available on request

CAPACITY (kg)	MAX LIFT HEIGHT (mm)	FORKS L x W (mm)	LIFT	ORDER REF	PRICE
500	1120	1150 x 545	Manual	VVR 500/1200	£2,725.00
500	1600	1150 x 545	Manual	VVR 500/1600	£2,795.00
500	2000	1150 x 545	Manual	VVR 500/2000	£3,455.00
500	2500	1150 x 545	Manual	VVR 500/2500	£3,555.00
500	3000	1150 x 545	Manual	VVR 500/3000	£3,685.00

### OPTIONS

Optional Straddle Legs	VVR500-STR	£425.00
Optional Adjustable Forks	VVR500-ADJ	£455.00



VVR 500/1600 Straddle Stacker with Adjustable Forks



## Standard Manual Pallet Stackers

- Robust construction
- Fixed forks
- Swivel castor steer wheels
- Safety valve prevents overloading
- Adjustable lowering speed

CAPACITY (kg)	MAX LIFT HEIGHT (mm)	FORKS L x W (mm)	LIFT	ORDER REF	PRICE
1000	1200	1150 x 550	Manual	KI 1000/1200	£1,195.00
1000	1600	1150 x 550	Manual	KI 1000/1600	£1,295.00
1000	2500	1150 x 580	Manual	KI 1000/2500	£1,595.00
1000	3000	1150 x 580	Manual	KI 1000/3000	£1,645.00
1500	1600	1150 x 550	Manual	KI 1500/1600	£1,845.00



## 1000kg Manual Stackers with Adjustable Forks

- Robust construction
- Adjustable forks fitted as standard
- Swivel castor steer wheels
- Safety valve prevents overloading
- Adjustable lowering speed
- Special versions available: including attachments, special sizes, lift heights or capacities, galvanised and stainless steel finish and more

CAPACITY (kg)	MAX LIFT HEIGHT (mm)	FORKS L x W (mm)	LIFT	ORDER REF	PRICE
1000	1600	1060 x 310 - 940	Manual	KI 1000/1600A	£1,395.00
1000	2500	1060 x 310 - 840	Manual	KI 1000/2500A	£1,745.00



## 1000kg Straddle Pallet Stackers

- Robust construction
- Can handle closed-bottom pallets up to 1200 x 1200mm
- Straddle legs provide excellent balance
- Adjustable forks fitted as standard
- Swivel castor steer wheels
- Safety valve prevents overloading
- Adjustable lowering speed

CAPACITY (kg)	MAX LIFT HEIGHT (mm)	FORKS L x W (mm)	LIFT	ORDER REF	PRICE
1000	1600	1060 x 240 - 940	Manual	KI 1000/1600SA	£1,895.00
1000	2500	1060 x 240 - 700	Manual	KI 1000/2500SA	£2,195.00





## 1000kg Manual Pallet Stackers

- Robust construction
- Ergonomic pump handle
- Separate tiller handle
- Safety valve prevents overloading
- Fitted with chain link steering for easy operation
- Special versions available: including attachments, special sizes, lift heights or capacities, galvanised and stainless steel finish and more

CAPACITY (kg)	MAX LIFT HEIGHT (mm)	FORKS L x W (mm)	LIFT	ORDER REF	PRICE
1000	1120	1150 x 545	Manual	VVR 1000/1120	£2,845.00
1000	1600	1150 x 545	Manual	VVR 1000/1600	£2,935.00
1000	2000	1150 x 545	Manual	VVR 1000/2000	£3,585.00
1000	2500	1150 x 545	Manual	VVR 1000/2500	£3,675.00
1000	3000	1150 x 545	Manual	VVR 1000/3000	£3,795.00

### OPTIONS

Optional Straddle Legs	VVR-STR	£425.00
Optional Adjustable Forks	VVR-ADJ	£455.00



VVR 1000/2000



## Heavy Duty Manual Pallet Stackers

- Robust construction
- Ergonomic pump handle
- Separate tiller handle
- Safety valve prevents overloading
- Fitted with chain link steering for easy operation
- Special versions available: including attachments, special sizes, lift heights or capacities, galvanised and stainless steel finish and more

CAPACITY (kg)	MAX LIFT HEIGHT (mm)	FORKS L x W (mm)	LIFT	ORDER REF	PRICE
1200	1600	1150 x 545	Manual	VVR 1200/1600	£3,120.00
1500	1600	1150 x 545	Manual	VVR 1500/1600	£3,720.00
1800	1600	1150 x 545	Manual	VVR 1800/1600	£3,960.00
2000	1600	1150 x 545	Manual	VVR 2000/1600	£4,440.00



## 500kg Electric Lift Pallet Stackers

- Robust construction
- 500kg capacity
- Fork length: 1150mm
- Width over forks: 545mm
- Lowered fork height: 85mm
- Straddle legs, adjustable forks and bespoke versions available
- Special attachments available on request

CAPACITY (kg)	MAX LIFT HEIGHT (mm)	FORKS L x W (mm)	LIFT	ORDER REF	PRICE
500	1120	1150 x 545	Electric	VVE 500/1120	£3,285.00
500	1600	1150 x 545	Electric	VVE 500/1600	£3,390.00
500	2000	1150 x 545	Electric	VVE 500/2000	£4,295.00
500	2500	1150 x 545	Electric	VVE 500/2500	£4,555.00
500	3000	1150 x 545	Electric	VVE 500/3000	£4,675.00
500	3500	1150 x 545	Electric	VVE 500/3500	£4,855.00

OPTIONS		
Optional Straddle Legs	VVE-STR	£425.00
Optional Adjustable Forks	VVE-ADJ	£455.00



Adjustable forks and Straddle legs option

VVE 500/2500

## 1000kg Electric Lift Pallet Stackers

- Battery powered lift, manual traction
- Ideal for small to medium sized warehouses
- 1000kg capacity
- Fork length: 1150mm
- Width over forks: 570mm
- Lowered fork height: 85mm
- Minimum recommended aisle width: 2200mm

CAPACITY (kg)	MAX LIFT HEIGHT (mm)	FORKS L x W (mm)	LIFT	ORDER REF	PRICE
1000	1600	1150 x 570	Electric	KIE 1000/1600	£2,595.00
1000	2500	1150 x 570	Electric	KIE 1000/2500	£2,995.00
1000	3000	1150 x 570	Electric	KIE 1000/3000	£3,195.00

KIE 1000/2500

KIE 1000/3000

KIE 1000/1600



## 1000kg Heavy Duty Electric Lift Pallet Stackers

- Robust construction
- 1000kg capacity
- Fork length: 1150mm
- Width over forks: 545mm
- Lowered fork height: 85mm
- Straddle legs, adjustable forks and bespoke versions available
- Special attachments available on request

CAPACITY (kg)	MAX LIFT HEIGHT (mm)	FORKS L x W (mm)	LIFT	ORDER REF	PRICE
1000	1120	1150 x 545	Electric	VVE 1000/1120	£3,535.00
1000	1600	1150 x 545	Electric	VVE 1000/1600	£3,595.00
1000	2000	1150 x 545	Electric	VVE 1000/2000	£4,435.00
1000	2500	1150 x 545	Electric	VVE 1000/2500	£4,675.00
1000	3000	1150 x 545	Electric	VVE 1000/3000	£4,795.00
1000	3500	1150 x 545	Electric	VVE 1000/3500	£4,975.00
1000	3700	1150 x 545	Electric	VVE 1000/3700	£5,225.00

### OPTIONS

Optional Straddle Legs	VVE-STR	£425.00
Optional Adjustable Forks	VVE-ADJ	£455.00



VVE 1000/3500

## Special Pallet Stackers, Accessories & Options

- Robust construction
- 1000, 1200, 1500, 1800, 2000kg capacities

Prices start from: POA



Special Sizes



Military Applications



Galvanised or Stainless Steel Version



Drum Rotator / Wide Straddle Legs



Platform Attachment



Side Shift & Adjustable Forks

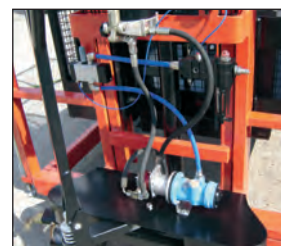

Pneumatic Lift



Boom Attachment

## UNIVERSAL FULLY POWERED STACKERS

The LiftMate LES/LESS Series offers several models of battery powered stackers which are lightweight and competitively priced yet powerful and reliable. Both drive and lift movement are operated by controls on an ergonomically designed handle. The LES/LESS range has been designed specifically for small warehouses and factories.

All stackers in this range are fitted with 2 powerful 120Ah batteries and on board charger which can be connected to standard mains 230V/13A 3-pin socket. These provide approximately 3 hours of operational charge.

### LES 10.16 & LES 10.30 Fully Powered Stackers

**LES models** have fixed width wrapover forks and are designed for handling Euro pallets and other open bottom pallets and cages.

- Battery powered lift and drive
- Light and versatile; compact and reliable
- Suitable for small factories and warehouses
- Wrapover forks
- On board charger
- Turning radius: 1400mm
- Chargeable from standard 230V/13A 3-pin socket
- CE certified
- Full 12 months warranty
- 240V charger - standard, included



LES 10.16

LES 10.30

CAPACITY (kg)	MAX LIFT HEIGHT (mm)	FORKS L x W (mm)	O/A LOWERED HEIGHT (mm)	MAST	BATTERY	ORDER REF	PRICE
1000	1600	1150 x 560	1985	Single	12V / 120Ah	LES 10.16	£4,495.00
1000	3000	1150 x 560	1985	Single	12V / 120Ah	LES 10.30	£4,995.00
Optional 110V Charger							£70.00

## LESS 10.16, LESS 10.25 & LESS 10.33 Fully Powered Straddle Stackers

**LESS models** have adjustable straddle legs and are ideal for handling imperial and CHEP pallets and similar closed bottom pallets and cages. They are equipped with adjustable forged forks, (210 - 810 mm), for loading special and even low profile pallets.

- Battery powered lift and drive
- Light and versatile; compact and reliable
- Suitable for small factories and warehouses
- Adjustable forks
- On board charger
- Turning radius: 1400mm
- Chargeable from standard 230V/13A 3-pin socket
- CE certified
- Full 12 months warranty
- 240V charger - standard, included



CAPACITY (kg)	MAX LIFT HEIGHT (mm)	FORK LENGTH (mm)	WIDTH OVER FORKS (mm)	O/A LOWERED HEIGHT (mm)	STRADDLE GAP (mm)	MAST	BATTERY	ORDER REF	PRICE
1000	1600	1150	210 - 810	2070	1255, 1090, 995*	Single	12V / 120Ah	LESS 10.16	£4,995.00
1000	2500	1150	210 - 810	1900	1255, 1090, 995*	Single	12V / 120Ah	LESS 10.25	£5,345.00
1000	3300	1150	210 - 810	2150	1255, 1090, 995*	Single	12V / 120Ah	LESS 10.33	£5,495.00
Optional 110V Charger									£70.00

\* Adjustable Straddle Gap

## 1200kg Standard Powered Pallet Stackers

- Compact design
- Up to 5 hours continuous use per day
- Battery: 2 x 12V / 130Ah
- Optional straddle legs
- Optional adjustable forks
- Optional attachments: booms, crane jibs, drum clamps etc

CAPACITY (kg)	MAX LIFT HEIGHT (mm)	MAST TYPE	O/A LOWERED HEIGHT (mm)	FORKS L x W (mm)	ORDER REF	PRICE
1200	1600	SIMPLEX	1990	1150 x 540	F12 APE	£9,995.00
1200	1600	DUPLEX	1300	1150 x 540	F12 APE 1.6	£10,495.00
1200	2500	DUPLEX	1750	1150 x 540	F12 APE 2.5	£10,995.00
1200	3000	DUPLEX	2000	1150 x 540	F12 APE 3.0	£11,995.00
1200	3500	DUPLEX	2250	1150 x 540	F12 APE 3.5	£12,995.00

OPTIONS			
	Optional straddle legs	APE-STR	£980.00
	Optional adjustable forks	APE-ADJ	£860.00



F12 APE 2.5 Straddle with adjustable forks



F12 APE 3.5

F12 APE 1.6

## Very Heavy Duty Fully Powered Pallet Stackers

- Very heavy duty design and manufacture
- Power steering fitted as standard
- Heavy duty battery
- Battery discharge indicator
- Operating hours meter
- Special versions available

Prices start from: POA

CAPACITY (kg)	MAX LIFT HEIGHT (mm)	FORKS L x W (mm)	BATTERY	ORDER REF
2000	1600 - 5800	1150 x 575	24V / 320Ah	LITE20
3000	1600 - 5800	1150 x 575	24V / 320Ah	LITE30



## Heavy Duty Counterbalanced Fully Powered Stackers

- Very heavy duty design and manufacture
- Power steering fitted as standard
- Width over forks: adjustable up to 700mm
- Heavy duty battery
- Battery discharge indicator
- Operating hours meter
- Special versions available

Prices start from: POA

CAPACITY (kg)	MAX LIFT HEIGHT (mm)	FORK LENGTH (mm)	BATTERY	ORDER REF
1200	1600 - 4500	1000	24V / 320Ah	LiCTS12
1500	1600 - 4800	1000	24V / 375Ah	LiCTS15
2000	1600 - 5800	1000	24V / 500Ah	LiCTS20



## Special Models of Powered Pallet Trucks

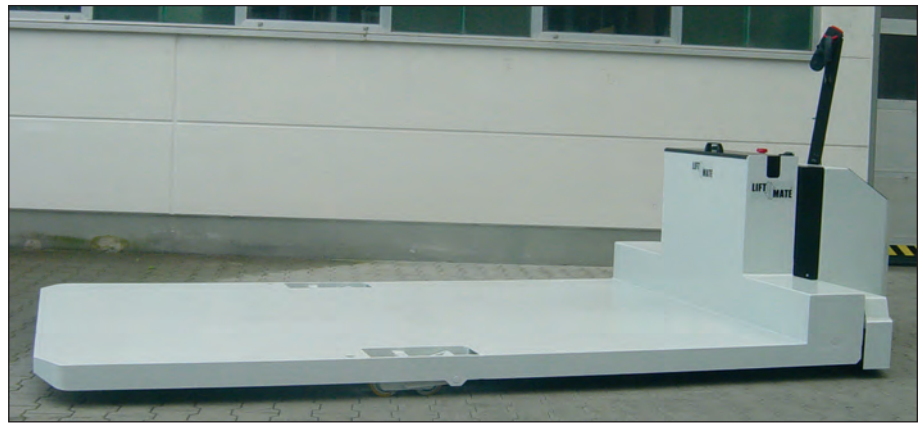

## Special Powered Trucks and Lifters Capacities up to 50,000kg



Stainless Steel Tilter



Electro-Magnet Tug



Rotating Clamp Lifter



Special Powered Trucks and Lifters  
Capacities up to 50,000kg

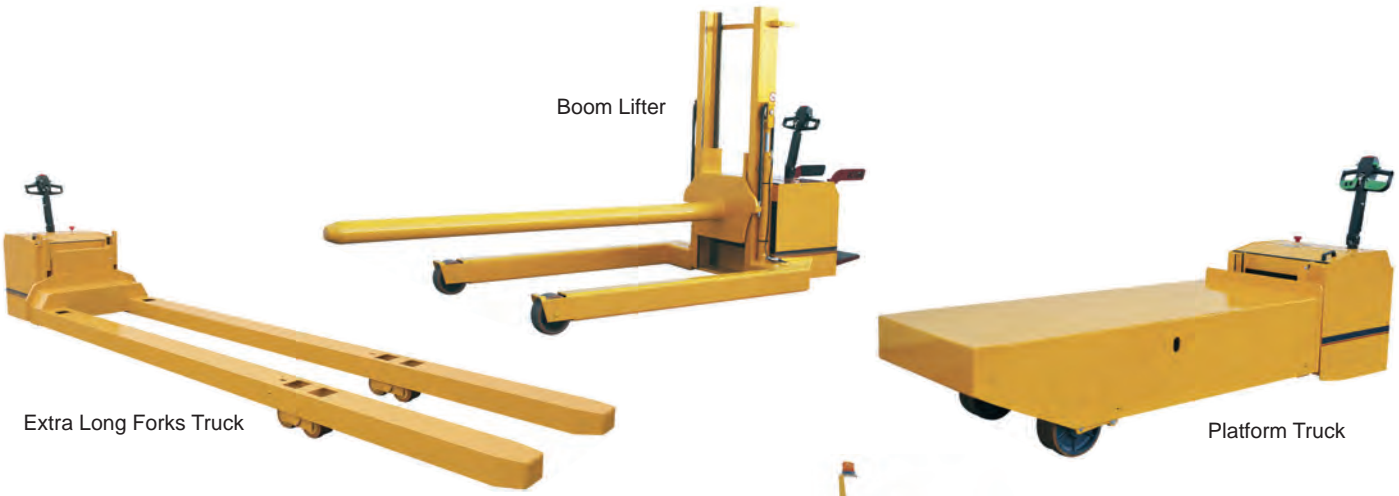

Extra Long Forks Truck

Boom Lifter

Platform Truck

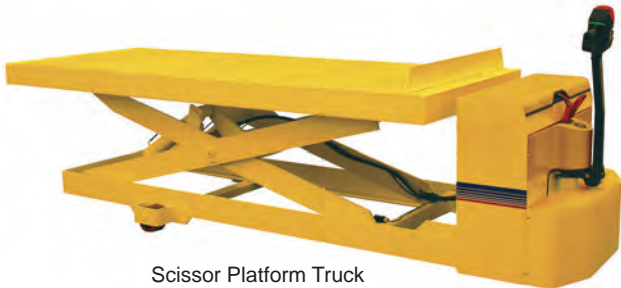

Scissor Platform Truck



Terrain Reel Lifter

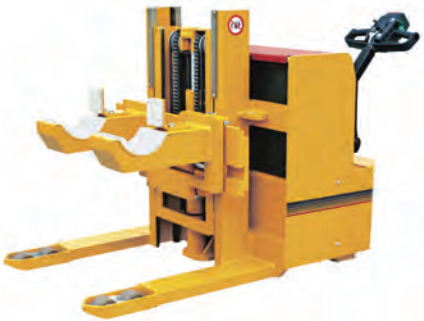

Axle Lifter



Wide Platform Truck with 4 Directional Travel

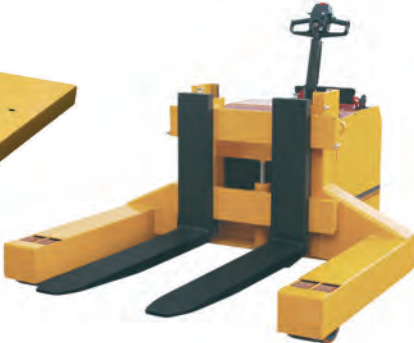

6 Ton Straddle Lifter



Reel Lifter



Rotating Forks Lifter



Scissor Forks Truck

## High Lift Pallet Trucks

- High lift pallet trucks easily lift loads up to 1000 or 1500kg
- Automatically braked when raised above 400mm
- High lift pallet trucks help minimise back strain
- Three position control lever
- Automatic descending speed control
- Quick lift as standard on manual models
- Manual lift override on electric models in case of flat battery
- Special sizes available



CAPACITY (kg)	LIFT TYPE	FORK DIMENSIONS L X W (mm)	MAX LIFT HEIGHT (mm)	LOWERED FORK HEIGHT (mm)	ORDER REF	PRICE
1000	MANUAL	1170 x 540	800	90	MHL540M	£745.00
1000	MANUAL	1170 x 680	800	90	MHL680M	£795.00
1500	MANUAL	1170 x 560	800	90	HBL15560M	£995.00
1500	MANUAL	1170 x 680	800	90	HBL15680M	£1,095.00
1000	ELECTRIC	1170 x 540	800	90	MHL540E	£1,995.00
1000	ELECTRIC	1170 x 680	800	90	MHL680E	£2,095.00
1500	ELECTRIC	1170 x 560	800	85	HBL15560E	£2,095.00
1500	ELECTRIC	1170 x 680	800	85	HBL15680E	£2,195.00

## Stainless Steel High Lift Pallet Truck

The stainless steel high lift pallet truck model is designed for corrosive, damp or harsh environments or applications where a high standard of hygiene is required such as meat or fish processing plants, dairies, pharmaceutical and chemical industries.



CAPACITY (kg)	LIFT TYPE	FORK DIMENSIONS L X W (mm)	MAX LIFT HEIGHT (mm)	LOWERED FORK HEIGHT (mm)	ORDER REF	PRICE
1000	MANUAL	1150 x 540	800	85	MHLS540M	£2,995.00
1000	ELECTRIC	1150 x 540	800	85	MHLS540E	POA

## Skid Lifters with Removable Platform

- Raise pallets or other items to correct working height
- Skid lifters help minimise back strain
- Combination of high lift pallet truck and lift table
- Fully welded heavy duty steel frame
- Total stop brake on castor wheel
- Foot operated pedal for easier and faster lifting
- Skid lifters can be moved even when fully raised
- Steering tiller handle on 1000kg models for easier and comfortable turning



PL50

CAPACITY (kg)	FORK WIDTH (mm)	FORK LENGTH (mm)	PLATFORM SIZE L X W (mm)	RAISED FORK HEIGHT (mm)	ORDER REF	PRICE
500	526	1115	1115 x 538	830	PL50S	£895.00
500	690	1115	1115 x 703	830	PL50L	£895.00
1000	526	1115	1115 x 538	830	PL100S	£1,095.00
1000	690	1115	1115 x 703	830	PL100L	£1,095.00



PL100



LT10E

## Manual & Electric Pallet Tilters

- Forks can be tilted up to 90°
- Handle can be turned and locked in position away from the work area
- Both models are supplied with parking brake and foot protectors on castors as standard
- Manual type: lift and tilt are performed by hand hydraulic action
- Electric type: lifting and lowering functions are built into the handle; tilting action is operated by remote control

CAPACITY (kg)	ANGLE OF TILT	LIFT/TILT	FORK WIDTH (mm)	FORK LENGTH (mm)	ORDER REF	PRICE
1000	90°	MANUAL	560	800	LT10M	£1,295.00
1000	90°	ELECTRIC	560	800	LT10E	£2,895.00



LT10M



Stainless Steel Pallet Tilter (Special)



Straddle Pallet Tilter (Special)

## Single Manual Scissor Lift Tables



- Capacity range from 150kg to 1500kg
- Heavy duty design
- Great stability and manoeuvrability
- Foot pump to lift platform
- Hand lever to release/lower platform
- Can be used at any height
- Both swivel wheels are fitted with total stop brakes
- Special bespoke designs available



CAPACITY (kg)	PLATFORM L x W (mm)	CLOSED HEIGHT (mm)	RAISED HEIGHT (mm)	HANDLE HEIGHT (mm)	WHEELS DIA (mm)	WEIGHT (kg)	ORDER REF	PRICE
150	700 x 450	225	740	935	Ø 100	44	TXL150	£365.00
200	1000 x 500	340	1000	1055	Ø 200	70	TXL200	£565.00
300	855 x 500	340	915	970	Ø 125	75	TXL300	£525.00
500	855 x 500	340	910	970	Ø 125	79	TXL500	£595.00
500	1010 x 520	435	1000	1100	Ø 150	118	BSL50	£595.00
500	1600 x 800	310	910	970	Ø 125	134	TXL500L	£895.00
500	1200 x 800	355	1220	1100	Ø 150	160	BSL50LB	£895.00
700	1220 x 610	230	1075	935	Ø 100/125	158	BZL70B	£1,295.00
750	1010 x 520	442	1000	1100	Ø 150	120	BSL75	£645.00
800	1000 x 510	420	1000	970	Ø 150	115	TXL800	£665.00
1000	1015 x 515	380	1010	970	Ø 150	121	TXL1000	£795.00
1000	1010 x 520	445	950	1100	Ø 150	137	BSL100	£795.00
1000	1200 x 800	415	1250	1100	Ø 150	163	BSL100L	£995.00
1500	1220 x 610	420	1010	970	Ø 150	142	TXL1500	£1,095.00

## Double Manual Scissor Lift Tables

- Capacity range from 150kg to 800kg
- Heavy duty design
- Great stability and manoeuvrability
- Foot pump to lift platform
- Hand lever to release/lower platform
- Special bespoke designs available



CAPACITY (kg)	PLATFORM L x W (mm)	CLOSED HEIGHT (mm)	RAISED HEIGHT (mm)	HANDLE HEIGHT (mm)	WHEELS DIA (mm)	WEIGHT (kg)	ORDER REF	PRICE
150	700 x 450	310	1120	920	Ø 100	67	TXL150D	£565.00
150	830 x 500	435	1450	1050	Ø 150	91	BSL150D	£565.00
300	1010 x 520	435	1620	1130	Ø 150	134	BSL30D	£645.00
350	910 x 500	350	1300	970	Ø 125	103	TXL350D	£645.00
450	1030 x 610	295	1555	950	Ø 130/160	TBC	SCL450DM	£895.00
500	1010 x 520	450	1600	1185	Ø 150	144	BSL50D	£695.00
680	1210 x 610	475	1510	1020	Ø 150	176	TXL680D	£1,095.00
800	1010 x 520	470	1420	1185	Ø 150	150	BSL80D	£795.00
800	1220 x 610	485	1500	970	Ø 150	181	TXL800D	£995.00

## Electric Double Scissor Lift Tables

- Capacity range from 300kg to 800kg
- Robust construction
- Simple handle mounted control pad
- 12V maintenance free battery
- 700W dc power pack



CAPACITY (kg)	PLATFORM L x W (mm)	CLOSED HEIGHT (mm)	RAISED HEIGHT (mm)	HANDLE HEIGHT (mm)	WHEELS DIA (mm)	WEIGHT (kg)	ORDER REF	PRICE
300	1010 x 520	495	1600	1180	Ø 150	183	ESL30D	£1,895.00
500	1010 x 520	435	1618	1180	Ø 150	198	ESL50D	£1,995.00
800	1010 x 520	510	1440	1180	Ø 150	208	ESL80D	£2,095.00

## Scissor Lift Table Attachments

These attachments are designed to make scissor lift table loading and unloading operations easier. They can be fitted to BSL50, BSL75, BSL30D, BSL50D, ESL30D and ESL50D scissor lift tables only.

### Ball Transfer Top

Model: BSL/BTT

- Capacity: 450kg
- Platform Length: 1010mm
- Platform Width: 560mm
- Base Width: 500mm
- Height: 180mm
- Height (with guards): 220mm

**Price: £395.00**

### Straight Roller Track

Model: BSL/SRT

- Capacity: 450kg
- Length: 1010mm
- Width: 500mm
- Overall Length: 1025mm
- Overall Width: 535mm
- Height: 50mm
- Overall Height: 100mm
- No. of Rollers: 9

**Price: £365.00**

### Turntable Roller Track

Model: BSL/TRT

- Capacity: 200kg
- Top Length: 710mm
- Top Width: 505mm
- Rotating base Width: 535mm
- Height: 100mm
- No. of Rollers: 6

**Price: £495.00**



Ball Transfer Top



Straight Roller Track



Turntable Roller Track

## Aluminium Mobile Scissor Lift Table



- Lightweight and easy to use
- Manual hydraulic operation (foot pump)
- Handle folds down flat
- Fitted with two brakes for added safety
- Easy transportation and storage
- Powder coated finish



**Weighs 21kg only**

CAPACITY (kg)	PLATFORM L x W (mm)	CLOSED HEIGHT (mm)	RAISED HEIGHT (mm)	HANDLE HEIGHT (mm)	WHEELS DIA (mm)	WEIGHT (kg)	ORDER REF	PRICE
100	705 x 455	260	755	1000	Ø 100	21	BSL10ALU	£595.00

## Stainless Steel Mobile Scissor Lift Tables

- Suitable for a variety of lifting and loading operations
- Robust structure yet lightweight
- Fitted with two brakes for increased safety
- Ideal for pharmaceutical, food and beverages industries
- Nylon wheels



BSL25SS



BSL25SS Closed

CAPACITY (kg)	PLATFORM L x W (mm)	CLOSED HEIGHT (mm)	RAISED HEIGHT (mm)	HANDLE HEIGHT (mm)	WHEELS DIA (mm)	WEIGHT (kg)	ORDER REF	PRICE
150	700 x 450	305	785	1000	Ø 100	43.5	BSL15SS	£2,395.00
250	830 x 500	290	890	955	Ø 125	71.5	BSL25SS	£2,695.00
500	1010 x 520	350	980	985	Ø 150	94.5	BSL50SS	£3,495.00

**Low Profile Scissor Lifts**

- Low profile pallet positioner
- Safe 415V 3-phase operation
- Safety anti-trap bar under table edge
- HY1001 model is suitable for all pallets up to 1100 x 1200mm
- HU1000 model is suitable for open-bottom pallets e.g. Euro Pallets



HY1001



HU1000



HY1001 Lowered

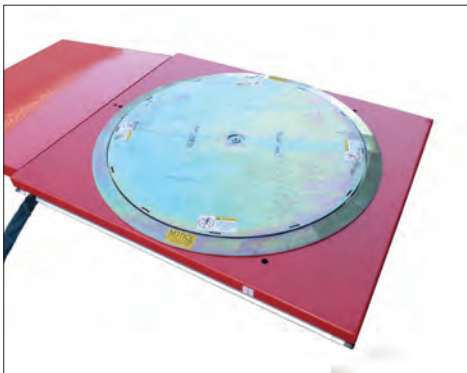

1000kg capacity Turntable Accessory for HY1001-1250

TYPE	CAPACITY (kg)	PLATFORM L x W (mm)	CLOSED HEIGHT (mm)	RAISED HEIGHT (mm)	WEIGHT (kg)	ORDER REF	PRICE
U-Shape	1000	1420 x 1140	85	860	134	HU1000	£2,595.00
Table With Ramp	1000	1450 x 1140	85	860	91	HY1001	£2,595.00
Table With Ramp	1000	1450 x 1250	85	860	92	HY1001-1250	£2,995.00
1000kg capacity Turntable Accessory for HY001-1250							£1,995.00

**SPECIAL MODELS OF SCISSOR LIFT TABLES**



ATEX Scissor Lift Table with Raised Frame Platform



Scissor Lift Table with Roller Top and Stabilising Screw Legs



Scissor Lift Table with Scale



Scissor Lift Table with Stainless Steel Top with Sides



with V-block Top and Side Controls

## Machinery Toe Jacks

- Designed for raising loads and placing shifting-skates underneath them
- Also used for general repairs, maintenance and for installation of heavy items
- Dual lifting capability: loads can be lifted using the toe or the head of the jack
- The 12000kg model has 2 toe positions and wheels for easy manoeuvring
- Adjustable lowering speed
- Removable pump handle
- Overload protection



TBL60

6t lifting capacity on toe  
7.5t lifting capacity on head



TBL120

12t lifting capacity on toe  
15t lifting capacity on head

CAPACITY (kg)	LIFT HEIGHT ON TOE (mm)	LIFT HEIGHT ON HEAD (mm)	WEIGHT (kg)	ORDER REF	PRICE
6000	35 -195 (single stage)	320 - 560	25.5	TBL60	£285.00
12000	40 -180 (two stage)	325 - 545	68	TBL120	£595.00

## Hydraulic Toe Jacks

- Designed for raising loads and placing shifting-skates underneath them
- Dual lifting capability: loads can be lifted using the toe or the head of the jack
- Suitable for repair and installation work of machines
- Ultra low-profile, compact and strong
- Three adjustable toe heights
- The hydraulic pumps of the jacks are protected by a robust lift housing
- The hydraulic toe jacks are supplied with a two part pump handle
- Adjustable swivel support legs as standard

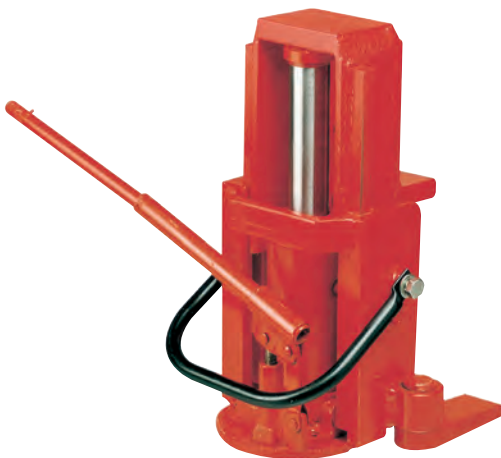

TGL30



TGL80

CAPACITY (kg)	LIFT HEIGHT ON TOE (mm)	LIFT HEIGHT ON HEAD (mm)	WEIGHT (kg)	ORDER REF	PRICE
3000	15 -240 (3 stage)	250 - 380	22	TGL30	£315.00
8000	25 -295 (3 stage)	270 - 410	28	TGL80	£345.00



## Rotational Hydraulic Toe Jacks

- Designed for raising loads and placing shifting-skates underneath them
- Also used for general repairs, maintenance and for installation of heavy items
- Dual lifting capability: loads can be lifted using the toe or the head of the jack
- Compact and stable construction
- Can be used in any position (pumps sideways and upside down)
- Housing revolves 360 degrees
- Adjustable lowering speed
- Removable pump lever
- Overload protection valve



HML50

HML100

HML250

CAPACITY (kg)	LIFT HEIGHT ON TOE (mm)	LIFT HEIGHT ON HEAD (mm)	WEIGHT (kg)	ORDER REF	PRICE
5000	25 -220 (single stage)	368 - 573	25	HML50	£345.00
10000	30 -260 (single stage)	420 - 650	35	HML100	£455.00
25000	58 -273 (single stage)	505 - 720	102	HML250	£995.00

## SPECIAL JACK MODELS

Forklift Jack



Nickel Plated Jack



50t Jack

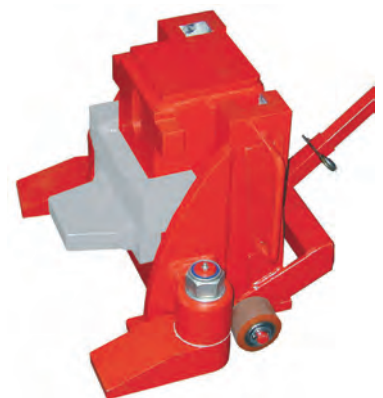

## Individual Skates

- Industrial shifting skates are designed for moving heavy objects
- They are ideal for moving factory machinery, power generators, large steel constructions etc
- Loads can be raised using either a roller crowbar or a hydraulic jack
- Skates are maintenance free with sealed bearings
- They are fitted with handles for ease of carrying and positioning
- The tops of the skates are covered with an anti-slip rubber mat for stability and protection of loads

CAPACITY (kg)	NUMBER OF ROLLERS	ROLLERS (mm)	DIMENSIONS L x W x H (mm)	O/A LENGTH WITH HANDLE	WEIGHT (kg)	ORDER REF	PRICE
1000	4	Ø 100 x 35 Nylon	330 x 220 x 120	400mm	7	SF10	£85.00
2000	8	Ø 100 x 35 Nylon	330 x 220 x 120	400mm	8	SF20	£105.00
2500	2	Ø 85 x 90 Nylon	220 x 120 x 105	275mm	4	SF25	£85.00
3000	4	Ø 85 x 85 Nylon	330 x 220 x 120	400mm	9.5	SF30	£115.00
6000	6	Ø 85 x 90 Nylon	265 x 210 x 105	420mm	12	SF60	£145.00



## Heavy Duty Individual Skates with Swivel Castors

- Skates with swivel castors are designed to travel in any direction
- The 360 degree rotating castors enables quick change of direction
- Circular anti-slip mat on top of skates for stability and protection of loads
- Supplied with a two-piece removable steering handle - easy handle storage



CAPACITY (kg)	NUMBER OF ROLLERS	POLYURETHANE ROLLERS (mm)	DIMENSIONS L x W x H (mm)	WEIGHT (kg)	ORDER REF	PRICE
2000	3	Ø 80 x 70	410 x 500 x 110*	25	SC203	£235.00
3000	4	Ø 80 x 70	410 x 470 x 110*	29.6	SC304	£255.00
4000	5	Ø 80 x 70	510 x 585 x 110*	37	SC405	£295.00

\* Height: without handle

## Individual Skates with Swivel Castors

- Skates with swivel castors are designed to travel in any direction
- They can be used to change direction quickly and almost on the spot
- 2 swivel castor skates (SC102) are often used in conjunction with two or more all-swivel castor skates (SC104)
- The 2 Swivel Castors Skate (SC102) has two swivel castors and two fixed castors
- The tops of the skates are covered with an anti-slip rubber mat for stability and protection of loads



CAPACITY (kg)	SWIVEL CASTORS (mm)	FIXED CASTORS (mm)	DIMENSIONS L x W x H (mm)	O/A LENGTH WITH HANDLE (mm)	WEIGHT (kg)	ORDER REF	PRICE
1000	2x Ø 75 x 46 Nylon	2x Ø 100 x 35 Nylon	430 x 340 x 120	500mm	13	SC102	£165.00
1000	4x Ø 75 x 46 Nylon		430 x 340 x 120	500mm	14	SC104	£215.00

## Adjustable Skates Pairs

- Adjustable skates consist of a pair of skates each. These can be linked using two steel rods
- The rods are loose inside tubes welded onto the sides of the skates
- The rods prevent the skates from skidding and travelling at different speeds
- The distance between the skates can be freely adjusted from 500 to 1200mm (model CM60)
- The distance between the skates can be freely adjusted from 720 to 1200mm (models CM120 and CM240)
- The tops of the skates are covered with a rubber mat for stability and protection of loads



CAPACITY (kg)	NUMBER OF ROLLERS	ROLLERS (mm)	DIMENSIONS L x W x H (mm)	O/A DIMENSIONS L x W (mm)	WEIGHT (kg)	ORDER REF	PRICE
6000	8	Ø 85 x 90 Nylon	250 x 200 x 115	325* x 270**	30	CM60	£295.00
12000	12	Ø 85 x 90 Nylon	350 x 200 x 115	420* x 270**	38	CM120	£385.00
24000	16	Ø 83 x 85 Steel	425 x 220 x 115	495* x 290**	65	CM240	£495.00

\* with handle / \*\* with side rod tubes

## Steerable Skates

- Industrial shifting skates are designed for moving heavy objects
- They are ideal for moving factory machinery, power generators, large steel constructions etc
- The load can be raised using either a roller crowbar or a hydraulic jack
- Skates are maintenance free with sealed bearings
- They are fitted with handles for ease of carrying and positioning
- The tops of the skates are covered with an anti-slip rubber mat for stability and protection of loads
- Steerable skates are usually used together with an adjustable skate pair
- One or two steerable skates can be used to form a skate set
- Each skate has a high quality turntable and packing plate covered with a rubber mat
- The steering handles are 1m long
- The steering handles of the ST60 & ST120 models come with hitching loops to connect to tugs or forklifts



CAPACITY (kg)	NUMBER OF ROLLERS	ROLLERS (mm)	DIMENSIONS L x W x H (mm)	WEIGHT (kg)	ORDER REF	PRICE
3000	4	Ø 85 x 90 Nylon	310 x 255 x 105	15	ST30	£215.00
6000	8	Ø 85 x 90 Nylon	630 x 400 x 115	50	ST60	£395.00
12000	8	Ø 83 x 85 Steel	630 x 400 x 115	66	ST120	£485.00

## Complete Skate Set

- These are the most popular skate sets
- 1 x Steerable Skate and drawbar with 2 x Adjustable Skates and connecting rods
- We can offer skate sets with capabilities up to 128t as well as individual skates from stock



CAPACITY (kg)	ROLLERS (mm)	WEIGHT (kg)	ORDER REF	PRICE
6000	Ø 85 x 90 Nylon	31	ST30+2xSF25	£385.00
9000	Ø 85 x 90 Nylon	45	ST30+CM60	£510.00
12000	Ø 85 x 90 Nylon	80	ST60+CM60	£690.00
18000	Ø 85 x 90 Nylon	88	ST60+CM120	£780.00
24000	Ø 85 x 90 Nylon & Ø 83 x 85 Steel	104	ST120+CM120	£870.00
36000	Ø 83 x 85 Steel	131	ST120+CM240	£980.00

## Caterpillar Skate Kits

- Caterpillar style skate sets are ideal for transportation of very heavy items over good firm floors
- Each set consist of:
  - 4 caterpillar style (connected) roller skates
  - 2 turntables
  - 2 packing plates
  - 2 steering handles
  - 2 link-up bars and 1 draw bar
- Each set is supplied in a steel box for easy storage and transportation

- Suitable for installation and movement of heavy loads
- Steering handles provide precise control
- Travel speed up to 5m/min
- Minimum turning circle: 3mm

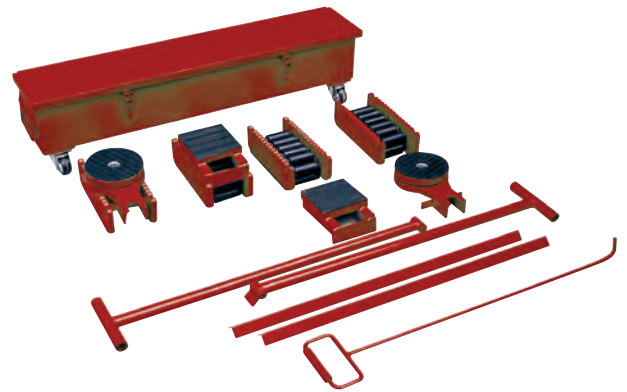

CAPACITY (kg)	ROLLERS (mm)	HEIGHT (mm)	WEIGHT (kg)	ORDER REF	PRICE
20000	Ø 18	108	50	SK20	£595.00
30000	Ø 24	117	58	SK30	£695.00
60000	Ø 30	140	92	SK60	£795.00



SK20 in box on castors



SK20

## Corner Skate Set

This set of 4 low level corner skates is designed to assist with the moving of large rectangular loads such as cupboards, office cabinets and storage systems. The skates are placed under each corner of the load to be moved.

- Pressed steel frame
- Non-marking swivel castors
- 600kg capacity over 4 corners

Order Ref	CS600
Capacity	600kg
Max. Load per Corner	150kg
Overall Dimensions	260 x 260 x 320mm
Internal Dimensions	130 x 130 x 190mm
Overall Height	85mm
Height of Load Platform	25mm
Wheels	Non-marking rubber
Wheels Diameter	Ø 50mm
Weight per Set	11kg
Price	£130.00

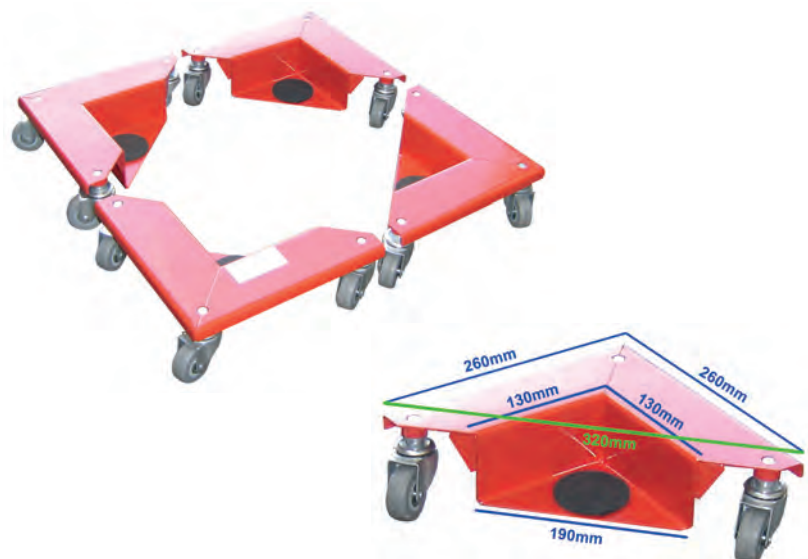

## Roller Crowbar

- Heavy duty reinforced crowbar
- Suitable for a variety of lifting and moving applications
- It can be used in conjunction with LiftMate skate sets

KI/RC1500/LONG

CAPACITY (kg)	OVERALL LENGTH (mm)	ROLLER SIZE (mm)	WEIGHT (kg)	MAX. SKATE HEIGHT (mm)	ROLLER MATERIAL	ORDER REF	PRICE
1500	2100	Ø 75	16.5	135	Steel	KI/RC1500	£145.00
1500	2000	Ø 100	19	235	Steel	KI/RC1500/LONG	£145.00



Long toe - 100mm rollers



Short toe - 75mm rollers



KI/RC1500

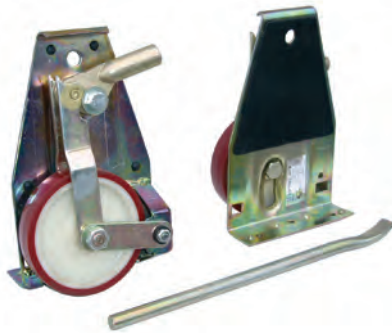

## Mechanical Furniture Mover Jack

- Lifts furniture from the floor and transports over short distances
- Ideal for use with cabinets, cupboards and other similar items
- A set consists of two units
- Supplied with a separate handle bar to lift objects off the floor
- Capacity: 1000kg, Wheels: Polyurethane, Weight: 10kg

MINIMUM TOE HEIGHT (mm)	MAXIMUM TOE HEIGHT (mm)	LIFTING RANGE AT TOE (mm)	ORDER REF	PRICE
12	50	38	MJ1000B	£135.00

## Furniture & Equipment Mover Sets

- Robust lifting mechanism
- For professional transport of heavy and bulky items
- Ideal for removal, maintenance and installation applications
- A set consists of two transport units
- Supplied with two 5 metre long securing load straps
- Polyurethane wheels

- Hydraulic lift
- Steering handle for control



FML60

Mechanical lift using spindle winch



FML180B



CAPACITY (kg)	RAISED HEIGHT (mm)	DIMENSIONS W x D x H (mm)	TOE PLATE W x D (mm)	TOE PLATE THICKNESS (mm)	WHEELS DIA (mm)	WEIGHT (kg)	ORDER REF	PRICE
600	410	600 x 410 x 810	225 x 120	7	Ø 150	25	FML60	£625.00
1800	345	650 x 425 x 1240	590 x 60	7	Ø 150	90	FML180B	£845.00

## Workshop Cranes

- Quick lifting with a dual action pump
- 3 positions adjustable jib extension
- Chrome plated lifting piston and pump piston
- Relief valve to prevent overload
- Forged heavy duty swivel hook
- 110% overload tested before delivery
- Conforms to CE safety standards

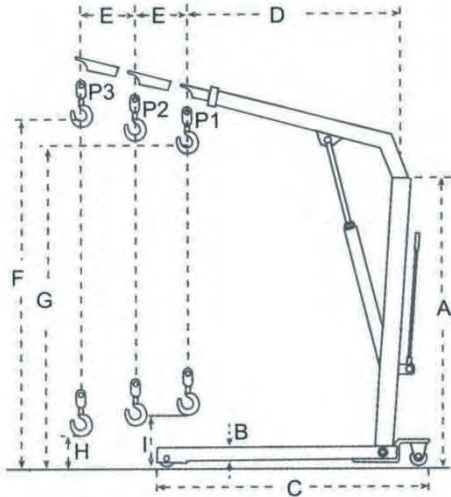

CAPACITY AT POSITION (kg)			DIMENSION (mm)									OVERALL WIDTH (mm)	WEIGHT (kg)	ORDER REF	PRICE
P1	P2	P3	A	B	C	D	E	F	G	H	I				
500	425	350	1410	165	1510	895	102	2120	1960	150	340	970	75	SC500A	£595.00

## More Crane Models

POA





150kg

501/KI/PL/150



250kg

502/KI/PL/250

Folding Handles

## Platform Trolleys

- Handle folds down flat over platform
- Steel base has a non-slip surface
- Two fixed wheels and two swivel castors
- Non-marking rubber wheels
- Easy storage

CAPACITY (kg)	DIMENSIONS L x W x H (mm)	PLATFORM SIZE L x W (mm)	HANDLES	WHEELS DIA (mm)	WEIGHT (kg)	ORDER REF	PRICE
150	740 x 490 x 865	635 x 490	1	Ø 100	12.5	501/KI/PL/150	£79.00
250	930 x 620 x 865	790 x 620	1	Ø 125	18.5	502/KI/PL/250	£99.00



300kg

505/KI/LUX/2



505/KI/LUX/1

## Large Platform Trolleys

- Fixed handles for added strength
- Optional additional handle
- Steel base has a non-slip surface
- Two fixed wheels and two swivel castors
- Non-marking rubber wheels

CAPACITY (kg)	DIMENSIONS L x W x H (mm)	PLATFORM SIZE L x W (mm)	HANDLES	WHEELS DIA (mm)	WEIGHT (kg)	ORDER REF	PRICE
300	1160 x 760 x 875	1020 x 760	1	Ø 160	41.5	505/KI/LUX/1	£169.00
300	1160 x 760 x 875	875 x 760	2	Ø 160	42	505/KI/LUX/2	£179.00



150kg



Folding Handle

## Aluminium Platform Trolley

- Lightweight aluminium design
- Handle folds down flat over platform
- Fitted with corner bumpers
- Quiet-running rubber wheels

CAPACITY (kg)	DIMENSIONS L x W x H (mm)	PLATFORM SIZE L x W (mm)	HANDLES	WHEELS DIA (mm)	WEIGHT (kg)	ORDER REF	PRICE
150	750 x 470 x 900	645 x 470	1	Ø 100	9	501/NPL/150	£109.00



## Two and Three Tier Trolleys

- Lightweight service trolley
- Fitted with two or three decks
- Ideal for catering environments
- Shelves have non-slip surface
- Shelves have all-round protection buffer
- Fitted with two handles
- Two fixed wheels and two swivel castors
- Non-marking rubber wheels



506/KI/SERV/2



507/KI/SERV/3

CAPACITY (kg)	DIMENSIONS L x W x H (mm)	PLATFORM SIZE L x W (mm)	NUMBER OF TIERS	WHEELS DIA (mm)	WEIGHT (kg)	ORDER REF	PRICE
120	745 x 485 x 865	630 x 485	2	Ø 125	20	506/KI/SERV/2	£149.00
120	745 x 485 x 865	630 x 485	3	Ø 125	25	507/KI/SERV/3	£189.00

## Folding Aluminium Platform Trolley

- Lightweight aluminium construction
- Folds and extends easily
- Great for storage and transport
- Telescopic handles
- Slide-in platform to reduce trolley length
- Two fixed wheels and two swivel castors
- Quiet-running rubber wheels



CAPACITY (kg)	PLATFORM SIZE L x W (mm)	PLATFORM FOLDED L x W (mm)	WHEELS DIA (mm)	WHEELS	WEIGHT (kg)	ORDER REF	PRICE
150	710 x 420	500 x 420	Ø 100	Solid Rubber	7.9	509/KI/PL/150/2	£64.00



## Heavy Duty Platform Trolley

- Narrow design to go through standard doors
- Tough plywood platform
- Welded steel frame
- Large platform area
- Choice of rubber or pneumatic wheels
- Available with 2 brakes



541/BI/PL/300

541/BI/PL/300/PN



541/BI/PL/300/B



541/BI/PL/300/PNB

CAPACITY (kg)	DIMENSIONS L x W x H (mm)	PLATFORM SIZE L x W (mm)	WHEELS	BRAKES	WHEELS DIA (mm)	WEIGHT (kg)	ORDER REF	PRICE
300	1230 x 600 x 935	1210 x 600	Solid rubber	-	Ø 160	32	541/BI/PL/300	£295.00
300	1230 x 600 x 935	1210 x 600	Solid rubber	2	Ø 160	32	541/BI/PL/300/B	£325.00
300	1230 x 600 x 935	1210 x 600	Pneumatic	-	Ø 225	32	541/BI/PL/300/PN	£495.00
300	1230 x 600 x 935	1210 x 600	Pneumatic	2	Ø 225	32	541/BI/PL/300/PNB	£545.00



## Garden/Store Truck with Fold Down Sides

- Heavy duty design
- Single Ackerman steering
- Sides and tailgate all fold down
- Sides are easily removable
- Ideal for both garden and light industrial use
- Fitted with large 330mm wheels
- Optional removable canvas lining



with Phenolic Deck



with Marine Plywood Deck



with Canvas Lining

CAPACITY (kg)	DIMENSIONS L x W (mm)	HEIGHT OF WALLS (mm)	NUMBER OF SIDES	WHEELS DIA (mm)	WEIGHT (kg)	ORDER REF	PRICE	
350	1380 x 615	280	4 Mesh	Ø 330	30	535/BI/TT/300	£295.00	
						Phenolic Deck for Garden Truck	535/BI/TT/DECK	£45.00
						Marine Plywood Deck for Garden Truck	535/BI/TT/DECK2	£35.00
						Optional Canvas Lining	535/BI/TT/LINING	£20.00

## Heavy Duty Nesting Cash & Carry Trolley

- Spring loaded platform allows nesting of trolleys
- Heavy duty design for busy applications
- Welded basket as standard
- Special sizes available



CAPACITY (kg)	DIMENSIONS L x W x H (mm)	PLATFORM SIZE L x W (mm)	WHEELS	WHEELS DIA (mm)	WEIGHT (kg)	ORDER REF	PRICE
500	1435 x 700 x 1070	1150 x 550	Solid rubber	Ø 200	39	540/CF/CC/500	£395.00
500	1435 x 700 x 1070	1150 x 550	Solid rubber	Ø 200	39	540G/PA/CC/500	£495.00
500	1435 x 700 x 1070	1150 x 550	Solid rubber	Ø 200	39	540G/PA/CC/500/PLY	£545.00
Parking Foot Brakes on Swivel Castors (per trolley)							£30.00

## Galvanised Nesting Cash & Carry Trolley

- Spring loaded platform allows nesting of trolleys
- Fitted with a zinc plated grill deck as standard
- Heavy duty design for busy applications
- Available with a plywood deck
- Welded basket as standard
- Special sizes available



## Narrow Cash & Carry Trolley

- Ideal for use in shops with narrow aisles
- Designed with an angle chassis frame
- Balance wheel construction
- Tubular end frame handles
- 350kg or 750kg capacity



CAPACITY (kg)	DIMENSIONS L x W x H (mm)	PLATFORM SIZE L x W (mm)	CORNER WHEELS	CENTRE AXLE WHEELS	WHEELS DIA (mm)	WEIGHT (kg)	ORDER REF	PRICE
350	1724 x 381 x 1067	1525 x 380	Solid rubber	Solid rubber	Ø 150 / 200	29	590/PA/NCC/350	£365.00
750	1724 x 381 x 1067	1525 x 380	Solid rubber	Polyurethane	Ø 150 / 200	29	590/PA/NCC/750	£395.00

## Universal Sack Truck

- General purpose professional quality sack truck
- Strong toe plate
- Durable red stove enamelled paint finish
- 200kg



## Delivery Driver's Hand Truck

- Ideal for deliveries and everyday use
- A favourite with professional delivery drivers
- Reinforced chassis



CAPACITY (kg)	DIMENSIONS H X W (mm)	TOE PLATE DEPTH (mm)	TOE PLATE WIDTH (mm)	WHEELS	WHEELS DIA (mm)	WEIGHT (kg)	ORDER REF	PRICE
200	1070 x 480	200	360	Solid rubber	Ø 200	9	403/KI/200	£99.00
200	1210 x 470	170	340	Solid rubber	Ø 200	13	404/KI/99/200	£149.00

## Rough Terrain Sack Truck

- Tubular steel sack truck
- Designed with a big toe plate
- Fitted with large pneumatic wheels



## Heavy Duty Rough Terrain Sack Truck

- Heavy duty sack truck
- 450kg Capacity
- Fitted with large pneumatic wheels



CAPACITY (kg)	DIMENSIONS H X W (mm)	TOE PLATE DEPTH (mm)	TOE PLATE WIDTH (mm)	WHEELS	WHEELS DIA (mm)	WEIGHT (kg)	ORDER REF	PRICE
400	1160 x 710	290	500	Pneumatic	Ø 300	15.5	416/CO/01B/400	£179.00
450	1170 x 620	230	500	Pneumatic	Ø 300	18.5	416/CO/94/450	£199.00

## Curved Back Sack Truck

- Heavy duty sack truck with large toe plate
- Curved back makes it ideal for carrying loads such as sacks, round bins or bottles
- Fitted with plastic grips with knuckle guards



417/CO/14/CB/250

250kg



See page 55 for load strap option

## Heavy Duty Sack Truck with Skids & Mesh Back

- Designed with a high back
- Mesh back to stop small items falling through
- Extra large toe plate



300kg

420/ME/6253/HBM

CAPACITY (kg)	DIMENSIONS H X W (mm)	TOE PLATE DEPTH (mm)	TOE PLATE WIDTH (mm)	WHEELS	WHEELS DIA (mm)	WEIGHT (kg)	ORDER REF	PRICE
250	1120 x 620	220	400	Rubber/Pneumatic/Puncture proof	Ø 260	10	417/CO/14/CB/250	£125.00
300	1350 x 500	300	475	Rubber/Pneumatic/Puncture proof	Ø 260	21.5	420/ME/6253/HBM	£219.00

## P-Shaped Handle Sack Truck

- Designed for everyday professional use
- P-shaped handle enables one-handed steering
- Favourite with delivery drivers



250kg

422/CO/38/P/250



## P-Shaped Handle Sack Truck

- Fitted with load protection strip to prevent scratching
- Designed with a high back for tall items
- Ideal for moving white goods and home appliances



200kg

422/KI/APL/200

CAPACITY (kg)	DIMENSIONS H X W (mm)	TOE PLATE DEPTH (mm)	TOE PLATE WIDTH (mm)	WHEELS	WHEELS DIA (mm)	WEIGHT (kg)	ORDER REF	PRICE
250	1310 x 530	230	350	Rubber/Pneumatic/Puncture proof	Ø 260	13.5	422/CO/38/P/250	£169.00
200	1330 x 550	225	500	Rubber/Pneumatic/Puncture proof	Ø 260	16	422/KI/APL/200	£179.00

## White Goods Appliance Hand Trucks

- Ideal for moving white goods and home appliances
- Fitted with load protection strips to prevent scratching
- Extra tall frame (448/CO/73/WG Model only)
- Foot pedal to help tilt loads



## Universal Curved Back Truck with Load Strap

- Curved back to carry bottles, drums, cans
- Supplied with a load retention strap
- Load Diameter: up to 380mm



CAPACITY (kg)	DIMENSIONS H X W (mm)	TOE PLATE DEPTH (mm)	TOE PLATE WIDTH (mm)	WHEELS	WHEELS DIA (mm)	WEIGHT (kg)	ORDER REF	PRICE
250	1075 x 560	155	340	Rubber/Pneumatic/Puncture proof	Ø 260	15.5	449/CO/03/WG	£145.00
250	1320 x 630	250	350	Pneumatic	Ø 260	15.5	448/CO/73/WG	£185.00
250	1300 x 500	280	230	Rubber/Pneumatic/Puncture proof	Ø 260	14	424/CO/31/SK/250	£159.00

## High Back Sack Truck with Skids

- Heavy duty high back sack truck
- Skids to handle kerbs and stairs
- Supplied with knuckle guards



## Very Tall High Back Sack Truck with Skids

- Very tall model of the high back sack truck
- Skids to handle kerbs and stairs
- Supplied with knuckle guards



## Beer Keg Truck

- Heavy duty beer barrel and keg truck
- Fitted with sliding catch to hold beer barrels in place
- Works with most standard kegs and barrels
- See page 54 for Stairclimber version



CAPACITY (kg)	DIMENSIONS H X W (mm)	TOE PLATE DEPTH (mm)	TOE PLATE WIDTH (mm)	WHEELS	WHEELS DIA (mm)	WEIGHT (kg)	ORDER REF	PRICE
250	1320 x 550	270	270	Rubber/Pneumatic/Puncture proof	Ø 260	14.5	424/CO/58/SK/250	£149.00
250	1600 x 550	300	300	Rubber/Pneumatic/Puncture proof	Ø 260	18.5	424/CO/58/SK/B/250	£179.00
250	1230 x 550	150	325	Rubber/Pneumatic/Puncture proof	Ø 260	16	429/CO/59/KEG/250	£179.00

## Folding Toe Plate Sack Truck

- Dual toe plate sack truck
- Built for large and heavy loads
- 250kg Capacity
- Fixed toe (L x W): 130 x 400mm
- Folding toe (L x W): 430 x 400mm



## Dual/Folding Toe Plate Sack Trucks

- Large fixed toe plate
- Larger folding toe plate for bulky items
- Reinforced chassis for heavy loads
- Fixed toe (L x W): 290 x 420mm
- Folding toe (L x W): 600 x 340mm
- 446/CO/90/DFXL
- Extra Long folding toe plate
- Fixed toe (L x W): 290 x 420mm
- Folding toe (L x W): 750 x 340mm



CAPACITY (kg)	DIMENSIONS H X W (mm)	TOE PLATE DEPTH (mm)	TOE PLATE WIDTH (mm)	WHEELS	WHEELS DIA (mm)	WEIGHT (kg)	ORDER REF	PRICE
250	1160 x 660	130 / 430	400 / 400	Rubber/Pneumatic/Puncture proof	Ø 260	15	423/CO/10/DF/250	£179.00
300	1260 x 620	290 / 600	420 / 340	Rubber/Pneumatic/Puncture proof	Ø 260	19	446/CO/90/DFL	£159.00
300	1260 x 620	290 / 750	420 / 340	Rubber/Pneumatic/Puncture proof	Ø 260	19.5	446/CO/90/DFXL	£179.00

## Heavy Duty Three Way Sack Truck

- Three-in-one convertible sack truck
- Serves both as sack truck and platform trolley
- Has a large fixed toe and a larger folding toe plate
- Middle position for supporting tall loads with ease, e.g. through doorways
- Fixed toe (L x W): 305 x 410mm
- Folding toe (L x W): 610 x 345mm



CAPACITY (kg)	DIMENSIONS H X W (mm)	TOE PLATE DEPTH (mm)	TOE PLATE WIDTH (mm)	WHEELS	WHEELS DIA (mm)	WEIGHT (kg)	ORDER REF	PRICE
300	1310 x 600	305 / 610	410 / 345	Rubber/Pneumatic/Puncture proof	Ø 260/100	20	447/CO/91/3WAY	£349.00

## Stairclimbing Sack Truck

- Basic stairclimbing sack truck model
- Designed for light to medium use
- Fitted with Tri-Star wheel assembly as standard



425/CO/23/SC/150

## Stairclimber Truck with Folding Toe

- Designed to easily climb stairs, doorsteps and kerbs
- Fitted with Tri-Star wheel assembly as standard
- The stairclimbing wheels come with roller bearings



426/BI/SC/FF/150

## Stairclimber Truck with Pneumatic Wheels

- Designed with a folding toe plate
- High back frame
- Fitted with large pneumatic wheels
- Quiet operation



428/CS/SC/FF/120

CAPACITY (kg)	DIMENSIONS H X W (mm)	TOE PLATE DEPTH (mm)	TOE PLATE WIDTH (mm)	WHEELS	WHEELS DIA (mm)	WEIGHT (kg)	ORDER REF	PRICE
150	1250 x 520	200	350	Solid rubber, Tri-Star assembly	Ø 140	13.5	425/CO/23/SC/150	£139.00
150	1305 x 580	170 / 435	400 / 335	Solid rubber, Tri-Star assembly	Ø 160	16.5	426/BI/SC/FF/150	£189.00
150	1320 x 620	180 / 460	400 / 345	Pneumatic, Tri-Star assembly	Ø 200	18	428/CS/SC/FF/120	£219.00

## Stairclimbing Keg & Barrel Sack Truck

- Heavy duty stairclimbing beer barrel and keg truck
- Fitted with sliding catch to hold barrels and kegs in place
- Works with most standard kegs and barrels
- Fitted with Tri-Star wheel assembly as standard



## Lightweight Aluminium Folding Sack Truck

- Designed for personal and light commercial use
- Telescopic handle
- Toe folds up for easy storage and transportation



430/KI/AL/F/90

CAPACITY (kg)	DIMENSIONS H X W (mm)	TOE PLATE DEPTH (mm)	TOE PLATE WIDTH (mm)	WHEELS	WHEELS DIA (mm)	WEIGHT (kg)	ORDER REF	PRICE
250	1230 x 550	150	325	Solid rubber, Tri-Star assembly	Ø 160	17	429/CO/59/KEG/250/SC	£249.00
90	1120 x 400	240	350	Solid rubber	Ø 160	6.5	430/KI/AL/F/90	£59.00



## Load Retention Straps

- Recommended accessory for most sack truck models
- Load retention straps are used for securing and transporting bulky or unstable loads safely
- Our load straps are designed to clip onto the chassis of most sack trucks using plastic hooks.
- They are tightened and adjusted by either a standard cam buckle or a ratchet operation.

### Standard Cam Buckle



LENGTH (cm)	ORDER REF	PRICE
40+150	STP/CB/150	£9.00
40+300	STP/CB/300	£10.00



### Ratchet



LENGTH (cm)	ORDER REF	PRICE
40+150	STP/RA/150	£10.00
40+300	STP/RA/300	£11.00

## Hand Truck Kerb Ramp

- Designed to assist hand truck operators when moving loads over kerbs or steps
- Eliminates the need to lift or push loaded hand trucks over kerbs or steps
- Prevents damage to the load or injury to the hand truck operator
- Lightweight and portable
- Molded engineered plastic
- Non-skid surface prevents slipping
- Easy storage
- Strong and durable
- Designed for use with kerbs or steps up to 200mm high

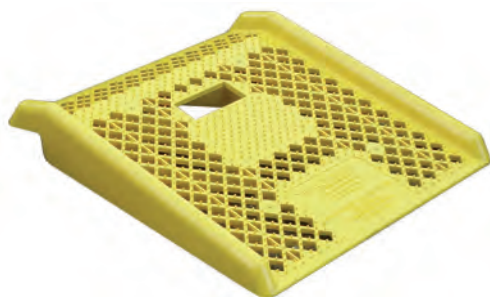

Load Capacity	270kg
Overall Length	685mm
Overall Width	685mm
Height of Kerb	200mm
Weight	4kg
Order Ref	PKR220
Price	£114.00



## Ruxxac Hand Trucks

- Designed to fold into a compact size for easy storage
- Ideal for both business and domestic use
- Ready to use within seconds from folded position
- Toe plate and wheels open simultaneously
- Designed with synthetic handles for comfortable steering
- “Spannfix” system fastening strap secures load to truck
- Aluminium toe plate and steel tubes
- Puncture proof wheels

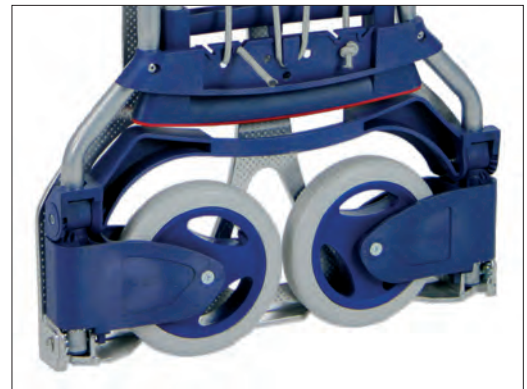

Wheel truck into tight spaces with the Rolling function\*

\* Rolling Function



Ruxxac Business XL Hand Truck  
472/RX/BXL/125

Stainless Steel Chassis



Ruxxac Business Hand Truck  
471/RX/BUS/125



Ruxxac Exclusive Hand Truck  
475/RX/EX/125



CAPACITY (kg)	OPEN DIMENSIONS D x W x H (mm)	FOLDED DIMENSIONS D x W x H (mm)	THICKNESS FOLDED (mm)	TOE PLATE D x W (mm)	WHEEL Ø x W (mm)	WEIGHT (kg)	ORDER REF	PRICE
125	460 x 490 x 1030	55 x 490 x 685	55	250 x 490	185 x 40	5.7	471/RX/BUS/125	£109.00
125	620 x 490 x 1130	55 x 490 x 735	55	410 x 490	185 x 40	6.1	472/RX/BXL/125	£129.00
125	620 x 490 x 1130	55 x 490 x 735	55	410 x 490	185 x 40	6	475/RX/EX/125	£189.00

Ruxxac Hand Trucks

- Designed to fold into a compact size for easy storage
- Ideal for both business and domestic use
- Ready to use within seconds from folded position
- Toe plate and wheels open simultaneously
- Designed with synthetic handles for comfortable steering
- Aluminium toe plate and steel tubes
- Puncture proof wheels



“Spannfix” system fastening strap easily secures load to truck



Ruxxac Cross Hand Truck  
475/RX/TR/100



Plastic Grip Handles & \*Rolling Function



50 x 100mm  
Frame Grid

Ruxxac Parcel Hand Truck  
473/RX/PAR/125

\* Rolling Function



Ruxxac Jumbo Hand Truck  
474/RX/JU/250

CAPACITY (kg)	OPEN DIMENSIONS D x W x H (mm)	FOLDED DIMENSIONS D x W x H (mm)	THICKNESS FOLDED (mm)	TOE PLATE D x W (mm)	WHEEL Ø x W (mm)	WEIGHT (kg)	ORDER REF	PRICE
100	615 x 615 x 1110	120 x 480 x 720	120	410 x 480	180 x 95	6.3	475/RX/TR/100	£149.00
125	620 x 490 x 1100	110 x 490 x 1100	110	410 x 490	185 x 40	5.9	473/RX/PAR/125	£129.00
250	620 x 655 x 1250	120 x 595 x 840	120	420 x 595	215 x 40	11.4	474/RX/JU/250	£289.00

## Fold-It Collapsible Aluminium Cart

- All-purpose collapsible and portable cart
- Folds easily for convenient storage
- Unfolds in less than a minute
- High-grade aluminium construction
- Folds small enough to fit in trunk of car
- Completely rust and corrosion resistant
- Removable front gate allows for larger load
- Large pneumatic wheels ideal for rough terrain
- Release spring action handle to start unfolding



Optional Mud Wheels



Optional Beach Wheels

Load Capacity	150kg
Overall Dimensions (LxWxH)	1430 x 735 x 585 mm
Folded Size (LxWxH)	1025 x 250 x 600 mm
Overall Cart Box Width	620mm
Inside Cart Box Size (LxWxH)	955 x 570 x 280 mm
Outside Wall Height (Side/Front)	360 / 330 mm
Wheel Material	Pneumatic
Wheel Diameter	495mm
Approx. Weight	15kg
Order Ref	LFI-150
Price	£395.00

OPTIONAL WHEELS	ORDER REF	PRICE
Puncture Proof Wheels	LFI-PP	£160.00
Mud Wheels Kit	LFI-MW	£370.00
Beach Wheels Kit	LFI-BW	£395.00

ACCESSORIES	ORDER REF	PRICE
Rear Gate	LFI-RG	£30.00
Full Height Rear Gate*	LFI-FHRG	£35.00
Trailer Hitch	LFI-TH	£45.00
Bicycle Hitch	LFI-BH	£50.00

\* Handles must be removed to install Full Height Rear Gate



Rear Gate



Full Height Rear Gate\*



Trailer Hitch



Bicycle Hitch

## Folding the Fold-It Cart





## CREATE YOUR CUSTOMISED MAGLINER HAND TRUCK

You can design and build your own Magliner hand truck that perfectly fits your needs by combining parts from our modular component system.

By selecting your preferred frame, handle, nose plate and wheels as well as optional accessories, if required, you end up with a customized Magliner hand truck of your choice.

Magliner Hand Trucks are lightweight, strong and of professional quality. They have a capacity of 225kg.

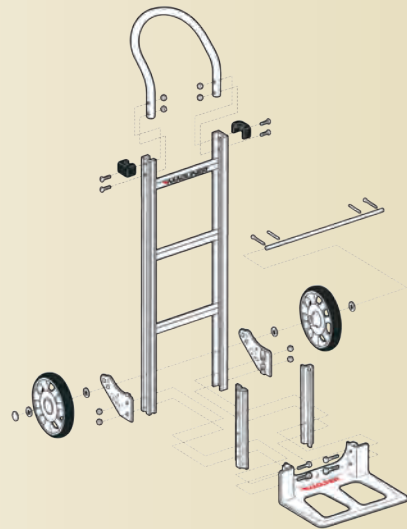

**Frame**  
2



Example of an assembled Magliner Hand Truck

**Handle**  
30



**Nose**  
HA

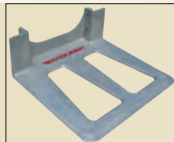

**Wheels**  
1010



**Accessory**  
C5 Stair Climber



**Order Ref:**  
230-HA-1010-C5

### Magliner Hand Truck Completion Kit

Each Magliner Hand Truck also requires a completion kit. This is a set of small parts including brackets, axle, bolts etc. This kit is included in the *Complete Hand Trucks'* prices on the following pages.

## COMPLETE HAND TRUCKS



£211.80

**111-E1-825**

- Straight back **frame**
- Basic 'U' loop **handle**
- 355 x 230mm extruded aluminium flush mount **nose**
- 200mm solid rubber **tyres**



£248.00

**111-K1-1060**

- Straight back **frame**
- Basic 'U' loop **handle**
- 405 x 300mm extruded aluminium flush mount **nose**
- 250mm pneumatic **tyres**



£255.60

**116-HA-830**

- Straight back **frame**
- Standard double pistol grip **handle**
- 355 x 300mm die-cast **nose** with recessed heel
- 200mm ballon cushion rubber **tyres**



£271.20

**116-HA-1060**

- Straight back **frame**
- Standard double pistol grip **handle**
- 355 x 300mm die-cast **nose** with recessed heel
- 250mm pneumatic **tyres**



£264.60

**219-AA-1060**

- Straight lattice back **frame**
- 'U' loop **handle** with vinyl sleeve
- 355 x 190mm die-cast **nose** with recessed heel
- 250mm pneumatic **tyres**



£272.40

**115C-E1-815**

- Straight back **frame**
- 1520mm vertical loop **handle**
- 355 x 230mm extruded aluminium flush mount **nose**
- 200mm mould-on rubber **tyres**

## COMPLETE HAND TRUCKS



£294.60

**160-K1-1060**

- Straight back **frame**
- Vertical loop **handle** for Hi-U extension
- 405 x 300mm extruded aluminium flush mount **nose**
- 250mm pneumatic **tyres**



£292.20

**230-G1-1060**

- Straight lattice back **frame**
- Welded double grip **handle**
- 455 x 230mm extruded aluminium flush mount **nose**
- 250mm pneumatic **tyres**



£274.40

**515A-AA-1030**

- Curved back **frame** with moulded cross members for transporting barrels and kegs
- 1320mm vertical loop **handle**
- 355 x 190mm die-cast **nose** with recessed heel
- 250mm balloon cushion rubber **tyres**



£303.10

**522-K2-1010**

- Curved back **frame** with moulded cross members for transporting barrels and kegs
- Welded double grip **handle**
- 500 x 300mm extruded aluminium flush mount **nose**
- 250mm puncture proof **tyres**



£307.00

**215A-UA-1010**

- Straight lattice back **frame**
- 1320mm vertical loop **handle**
- 455 x 190mm die-cast **nose** with recessed heel
- 250mm puncture proof **tyres**



£318.20

**516-UA-1060-KEG**

- Curved back **frame** with moulded cross members for transporting barrels and kegs
- Standard double pistol grip **handle**
- 455 x 190mm die-cast **nose** with recessed heel
- 250mm pneumatic **tyres**
- **Sliding Keg Hook** - see page 72





## COMPLETE HAND TRUCKS



£319.00

**416-AA-1060-F3**

- Straight back **frame** with moulded cross members
- Standard double pistol grip **handle**
- 355 x 190mm die-cast **nose** with recessed heel
- 250mm pneumatic **tyres**
- 750 x 300mm extruded aluminium **channel extension**



£311.60

**416-AA-1060-F2**

- Straight back **frame** with moulded cross members
- Standard double pistol grip **handle**
- 355 x 190mm die-cast **nose** with recessed heel
- 250mm pneumatic **tyres**
- 500 x 300mm extruded aluminium **channel extension**



£376.00

**130-HA-825-F1**

- Straight back **frame**
- Welded double grip **handle**
- 355 x 300mm die-cast **nose** with recessed heel
- 200mm solid rubber **tyres**
- 600 x 300mm low-profile formed **plate extension**



£348.00

**230-K2-1010-WG**

- Straight lattice back **frame**
- Welded double grip **handle**
- 500 x 300mm extruded aluminium flush mount **nose**
- 250mm puncture proof **tyres**
- 245 x 95mm **wheel guards** prevent loads from rubbing against hand truck.



£372.60

**230-HA-1010-C5**

- Straight lattice back **frame**
- Welded double grip **handle**
- 355 x 300mm die-cast **nose** with recessed heel
- 250mm puncture proof **tyres**
- **Stair Climbers** with replaceable low friction polymer skid bars

£597.20

*Stairclimber Kit*  
Available separately  
£395.00



### Magliner Stairclimber Hand Truck

**215C-HA-SC-STRP**

Magliner Stairclimber Hand Truck fitted with a Tri-Star wheel assembly using double row, multi-directional wheels.

The rotating multi-directional wheels enables easy manoeuvrability in confined spaces.

## BOTTLED WATER TRAY TRUCKS



**128-HA-1060-4WB**

£512.40



**128-HA-1060-5WB**

£532.40

- 225kg capacity.
- Converts to hold a combination of boxes and bottle.
- Aluminium construction prevents rusting.
- Trays fold flat against frame when not in use so the truck can be used as a standard hand truck.
- Ideal for four or five 20 litre water bottles respectively.

**Straight back frame**

Square loop **handle** with foam grip

350 x 300mm die-cast **nose** with recessed heel

250mm pneumatic **tyres**

WHEEL OPTIONS : 1010, 1030, 830, 815 - see page 71

Stair Climber - see page 72

## NARROW AISLE HAND TRUCKS

- Designed with wheels tucked fully or partially behind the truck's frame
- The truck's narrow width enables great manoeuvrability in confined spaces
- The Narrow Aisle Mounting Kit is required for the Narrow Aisle Hand Truck

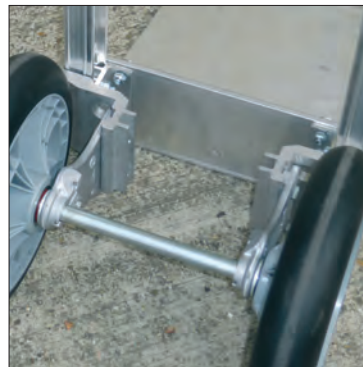

With optional Stairclimbers

KITS	ORDER REF	PRICE
Narrow Aisle Mounting Kit*	301045	£58.10
Narrow Magliner Nose Kit**	86094	£16.40

\*Price of Kit is added to price of Hand Truck parts, see pages 70-71

\*\*Required for E, G, K & T noses

## SPACE SAVING FOLDING TRUCKS

- Folds quickly and easily for convenient storage
- Large 225kg capacity, same as standard Magliner hand trucks
- Heavy-duty construction for superior strength and durability



**FTA11-E1-830**

£389.60



**FTA11-E1-1060**

£405.20

CAPACITY (kg)	DIMENSIONS - FOLDED H x W x D (mm)	DIMENSIONS - EXTENDED H x W x D (mm)	TOE PLATE SIZE W x D (mm)	WEIGHT	ORDER REF	PRICE
225	725 x 450 x 255	1245 x 450 x 405	355 x 190	10.5	FTA11-E1-830	£389.60
225	725 x 530 x 255	1245 x 530 x 405	355 x 190	11.5	FTA11-E1-1060	£405.20
225	725 x 480 x 255	1245 x 480 x 405	355 x 190	11.5	FTA11-E1-1030	£403.20
225	725 x 530 x 255	1245 x 530 x 405	455 x 190	12	FTA19-G1-1060-WG-C5	£490.80



**FTA11-E1-1030**

£403.20



**FTA19-G1-1060-WG-C5**

£490.80

## SELF-STABILISING HAND TRUCK KITS

- Self-Stabilising Magliner hand truck built with standard wheels and smaller Double or Triple Row, multi-directional wheels
- Choice of either double row or triple row, 125mm diameter multi-directional polyurethane rollers with sealed bearings
- The truck carries the load, not the operator
- Enables easy movement up kerbs or over obstructions without reversing
- Fully supported rotation allows easy manoeuvrability in confined spaces
- 'Integrated Kick Stand' holds the truck in an upright position when loading
- The truck design negates the need to support the load when stationary



Optional Stairclimbers



Double Row Multi-Directional Wheels



Triple Row Multi-Directional Wheels

KITS	WHEEL SIZE DIA. / W (mm)	ORDER REF	PRICE
Double Row*	125 x 38	302912	£310.00
Triple Row*	125 x 63	302916	£360.00

\*Price of Kit is added to price of Hand Truck parts, see pages 70-71

Optional Stairclimbers	86101	£72.20
------------------------	-------	--------

## TWO POSITION MAGLINER HAND TRUCK - Gemini Jr & Gemini Sr

Gemini Jr.  
£450.00



Gemini Sr.  
£470.00



### SPECIFICATIONS

Model	Gemini Jr.	Gemini Sr.
Capacity as hand truck	225kg	225kg
Capacity as platform truck	450kg	450kg
Overall width	530mm	530mm
Frame width	305mm	305mm
Deck width	305mm	305mm
Overall length - 4 wheel	1205mm	1415mm
Height as hand truck	1295mm	1550mm
Handle height as platform truck	1015mm	1140mm
Platform bed length	965mm	1295mm
Platform height from floor	265mm	265mm
Standard wheel (pneumatic)	250mm	250mm
Castors (standard swivel)	125 x 30mm	125 x 30mm
Nose	455 x 190mm	455 x 190mm
Shipping weight	19kg	20kg
Price	£450.00	£470.00

### FEATURES

- 2-in-1 truck converts from 2 to 4 wheels in seconds
- High capacities reduce number of trips per day
- Strong, lightweight construction reduces user fatigue
- Modular design means no welds to break
- All parts are replaceable for longer product life
- Optional accessories available

### GEMINI OPTIONS



£16.00  
Per Pair

#### Gemini Castor Brakes (Part #51010)

Optional brakes  
Width: 125mm  
Depth: 30mm



£41.00

#### C5 - Stair Climber (Part #86006)

Heavy-duty cast stair climber with replaceable low-friction polymer glide bars.

Fits on Senior model only



Gemini Jr.  
£106.60

Gemini Sr.  
£116.20

#### Snap On Decks

(Part #301644) - Gemini Jr.  
(Part #301645) - Gemini Sr.

- Snaps in place quickly and removes easily
- Snap On decks are not compatible with the F1 Folding nose

## THREE POSITION MAGLINER HAND TRUCK - TPAUA4



£700.00

- Standard two-wheel hand truck for general use. Built-in 685mm containment arm recesses into the frame when not in use.
- Inclined position for door entry and support with loads that do not stack well.
- Traditional four-wheel platform truck with 340kg capacity accommodates larger loads

### DIE-CAST NOSES

Part number	Width	Depth
300200	350mm	190mm
300196	350mm	300mm
300201	455mm	190mm



### SPECIFICATIONS

Two-Wheel Position	
Overall height	1295mm
Overall width	530mm
Capacity	225kg
Tyres	250mm
UA nose plate (W x L)	455 x 190mm
Folding recessed nose (W x L)	230 x 685mm
Folding recessed nose capacity	135kg

Four Wheel & Incline Position	
Overall height	1015mm
Cargo area (W x L)	300 x 1270mm
Capacity	340kg
Castors	125 x 30mm
Weight	19kg

### Wheel Options

**1060:** 250mm pneumatic tube-type tyre (Part #121060)

**1030:** 250mm puncture resistant, non-marking balloon cushion rubber (Part #101030)

**1010:** 250mm puncture resistant, microcellular foam tyre (Part #131010)

\* See page 71 for details

## FOUR OR SIX-WHEEL FOLDING PLATFORM TRUCK



£520.00

Main unit  
(Part # MT-TA)



- Folds flat quickly and easily for convenient storage e.g. in car trunk.
- Designed to manoeuvre easily through store aisles.
- Standard Castor brake helps prevent truck from moving on inclines.
- Non-slip grating keeps load in place during transport.
- Toggle latch to lock main unit and extension for increased load stability.
- Base unit stands upright for more convenient loading and unloading.

### SPECIFICATIONS

	Main Unit	Extension
Capacity	340kg	680kg
Length	785mm	784mm
Deck width	590mm	590mm
Overall width	715mm	685mm
Handle height	990mm	N/A
Weight	15kg	7.5kg

Main unit with extension  
(Part # MT1TA)

Wheels	Balloon cushion wheels
Wheel diameter	200mm



£790.00

## PLATFORM TRUCKS



PTK2436S1-Q



PTK3060S1-Q



PTK3672S1-Q

- Heavy-duty lightweight aluminium
- Smooth surface platform deck
- Reinforced box-frame construction for strength and durability

- Designed for tough load handling
- Durable extruded corner sockets integrated with frame
- One handle standard (second handle optional)
- Optional Castor parking brake

CAPACITY (kg)	PLATFORM SIZE L x W (mm)	WEIGHT (kg)	PART No.	PRICE
725, 1270 or 1360 kg	915 x 610	45	PTK2436S1-Q	POA
725, 1270 or 1360 kg	1525 x 760	61	PTK3060S1-Q	POA
725, 1270 or 1360 kg	1825 x 915	78	PTK3672S1-Q	POA

## Platform Truck Castors



Part #86135 - (Ø125mm / 725kg)  
Part #86151 - (Ø200mm / 1270kg)

**Black thermoplastic rubber:**  
Easy to push and roll with flat hard tread. Limited noise absorption. Performs well on all surfaces.



Part #86137 - (Ø125mm / 725kg)  
Part #86139 - (Ø200mm / 1270kg)

**Gray thermoplastic rubber:**  
Round tread, non-marking, good shock and noise absorption. Easy starting and rolling.



Part #86138 - (Ø125mm / 1360kg)  
Part #86152 - (Ø200mm / 1360kg)

**Maroon polyurethane:**  
Resistant to water, chemicals and solvents. Hard tread for easy rolling. Performs well on all surfaces.



Part #86067 - (Ø125mm)  
Part #86069 - (Ø200mm)

**Optional brake:**  
Foot operated, friction-type brake engages tyre surface. Attaches to swivel castor.

\* Wheels determine capacity of the platform trucks

## CASTOR DOLLIES



CDH2130  
£194.50

- Riveted aluminium construction
- Full 360-degree manoeuvrability for tight, sharp turns
- 75mm Polyolefin wheels on swivel castors



CDC2442  
£430.00

- High strength, welded extruded aluminium construction
- light, tough, highly manoeuvrable with swivel castors
- 125mm Phenolic type wheels, roller bearing mounted

CAPACITY (kg)	SIZE L x W (mm)	O/A HEIGHT (mm)	WEIGHT (kg)	PART No.	PRICE
405	610 x 455	130	5.5	CDH1824	£174.30
405	760 x 530	130	6	CDH2130	£194.50
900	1066 x 610	250	17.5	CDC2442	£430.00

## PLASTIC KERB RAMP

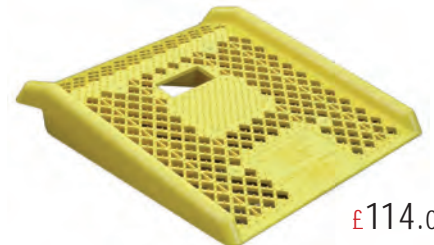

£114.00

- Light, portable, strong and durable
- Aggressive non-skid surface for secure footing
- Open surface to allow debris to pass through

### SPECIFICATIONS

PART No.	PKR220
Capacity	270kg
Overall Length	685mm
Overall Width	685mm
Kerb Height	200mm
Weight	4kg

## MAGLINER HAND TRUCK FRAMES



£46.00

**Frame 1**  
(Part #300001)

Straight back frame with cross braces to provide support for the hand truck.



£66.00

**Frame 2**  
(Part #300002)

Straight lattice back frame with cross braces and vertical strap.



£58.00

**Frame 4**  
(Part #300010)

Straight back frame with moulded cross braces. Similar to frame #1 but with high strength and impact-resistant polymer braces.



£58.00

**Frame 5**  
(Part #300021)

Curved back frame with moulded cross braces. Ideal for use with barrels, kegs and cylinders.

## MAGLINER HAND TRUCK HANDLES

### HORIZONTAL LOOP HANDLES



**Handle 11**  
£14.00

(Part #301000)  
"U" loop handle.



**Handle 12**  
£20.10

(Part #30100)  
Loop handle with universal brace.



**Handle 19**  
£25.00

(Part #301008)  
"U" loop handle with vinyl sleeve.



**Handle 22**  
£31.10

(Part #30102)  
"U" loop handle with vinyl sleeve and universal brace.



**Handle 24**  
£13.20

(Part #301001)  
Loop handle with straight top surface.

### VERTICAL LOOP HANDLES



£44.80

**Handle 15A**  
(Part #300981)

Standard  
Vertical loop handle.



£61.00

**Handle 15C**  
(Part #300978)

Tall  
Vertical loop handle.



£60.60

**Handle 60**  
(Part #300994)

Curved  
Vertical loop handle.

(The P-shaped Vertical Loop handles are not compatible with the Keg Hook accessory or Frame Extensions.)

### DOUBLE GRIP HANDLES



£24.00

**Handle 16**  
(Part #86031)

Bolted double pistol grip  
handle with universal brace.



£44.40

**Handle 30**  
(Part #301137)

Welded double grip handle.



## MAGLINER HAND TRUCK NOSES

### DIE CAST NOSES



£47.60

**AA**  
(Part #300200)

355 x 190mm die-cast nose with recessed heel



£75.20

**HA**  
(Part #300196)

355 x 300mm die-cast nose with recessed heel



£50.20

**UA**  
(Part #300201)

455 x 190mm die-cast nose with recessed heel

### EXTRUDED ALUMINIUM NOSES - All extruded aluminium noses require a 'Nose Mount Kit' (Part #86029) for assembly. PRICE: £9.80



£36.00

**E1**  
(Part #300244)

355 x 230mm extruded aluminium flush mount nose

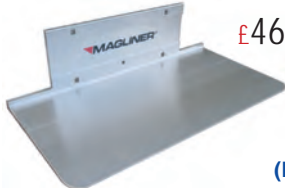

£46.00

**G1**  
(Part #300245)

455 x 230mm extruded aluminium flush mount nose



£44.00

**G2**  
(Part #300248)

455 x 230mm extruded aluminium flush mount nose



£52.20

**K1**  
(Part #300203)

405 x 300mm extruded aluminium flush mount nose



£58.20

**K2**  
(Part #300215)

505 x 300mm extruded aluminium flush mount nose



£46.34

**T1**  
(Part #302501)

260 - 300 x 300mm extruded aluminium tapered nose

## MAGLINER HAND TRUCK WHEELS



**815**  
(Part #10815)

£65.60  
Per Pair

8" Mould-on rubber wheel



**825**  
(Part #11825)

£52.00  
Per Pair

8" Puncture resistant, solid rubber wheel



**830**  
(Part #10830)

£56.40  
Per Pair

8" Puncture resistant, balloon cushion rubber

**Non-marking**



**1010**  
(Part #131010)

£92.00  
Per Pair

10" Puncture resistant foam wheel

**Non-marking**



**1060**  
(Part #121060)

£72.00  
Per Pair

10" Pneumatic tube-type wheel



**1030**  
(Part #101030)

£70.00  
Per Pair

10" Puncture resistant, balloon cushion rubber

**Non-marking**



**1070**  
(Part #111070)

£78.00  
Per Pair

10" x 2" Puncture resistant foam wheel

**Non-marking**



**1075**  
(Part #111075)

£102.00  
Per Pair

10" x 2.75" Puncture resistant foam wheel

**Non-marking**



**1080**  
(Part #111080)

£117.60  
Per Pair

10" x 3.5" Puncture resistant foam wheel

**Non-marking**

**Note: Completion Kit: £54.00, required to build all Magliner Hand Trucks**

## FOLDING NOSES (Only compatible with Die Cast noses: AM, UM and HM)

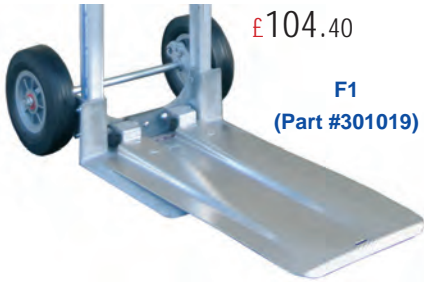

£104.40

**F1**  
(Part #301019)

600 x 300mm low-profile formed plate extension.  
(Not compatible with Snap On decks)



£56.00

**F2**  
(Part #301025)

500 x 300mm extruded aluminium channel extension



£63.40

**F3**  
(Part #301026)

750 x 300mm extruded aluminium channel extension



£41.00

**C5 - Stair Climber**  
(Part #86006)

Heavy-duty cast stair climber with replaceable low-friction polymer glide bars.



£23.60

**Wheel Guards**  
(Part #302520)

Wheel guards prevent loads from rubbing against hand truck wheels.



£15.40 (52")

£17.40 (55")

£19.50 (60")

£22.20 (62")

£27.00 (68")

**Hi-U Frame Extensions**  
Height - (52"/55"/60"/62"/68")

Hi-U frame extensions add height and stability for taller loads.

Not compatible with P-shaped vertical loop handles and Handle 30.



£31.80

**Padded Hi-U Frame Cover**  
(Part #302497)

Padded cover for Hi-U frame extensions.



£60.00

**Keg Hook Kit**  
(Part #32513K)

Sliding keg hook swings out of the way when not in use. 125mm hook for barrel-style kegs. **Not compatible with P-shaped vertical loop handles.**



£69.20

**Folding Nose Kit**  
(Part #302544)

Folding nose kit with lock rod allows aluminium extruded noses to fold flush with frame when not in use.



£190.00

**Double Grip Handle Paddle Brake**  
(Part #304161)

For handle 16



£190.00

**Loop Handle Paddle Brake**  
(Part #304160)

For handles 11, 12, 19 or 22

## ACCESSORY BAGS



**Bag 13**  
(Part #302680)

£54.00

- Overall: 330 x 200mm (L x W)
- Main pocket 305mm long x 200mm wide x 50mm deep with 1 Velcro strap.
- Outside pocket 130mm long x 135mm wide.



**Bag 16**  
(Part #302681)

£59.00

- Overall: 420 x 305mm (L x W)
- 2 top pockets, sealed with Velcro 250mm long x 150mm wide.
- 1 tool pocket 305mm wide x 85mm deep.



**Bag 18**  
(Part #302682)

£63.80

- Overall: 315 x 305mm (L x W)
- 1 pocket 280mm deep x 230mm wide.
- Holds a 250mm high x 500mm diameter can.



**Bag 29**  
(Part #302683)

£70.00

- Overall: 735 x 305mm (L x W)
- 2 top pockets, sealed with Velcro 265mm long x 150mm wide.
- 1 tool pocket 305mm wide x 85mm deep.
- 1 pocket 290mm wide x 305mm deep.

# WHEELS

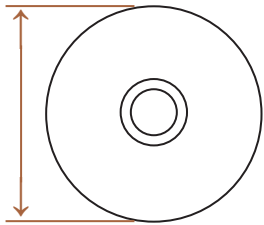

WHEEL DIAMETER

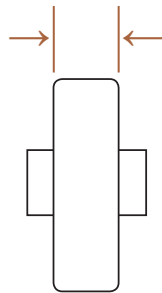

TREAD WIDTH

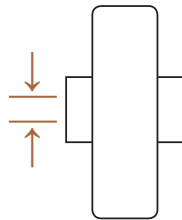

BORE

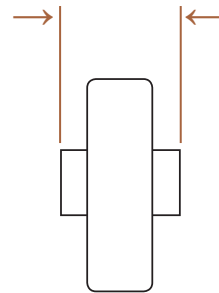

HUB LENGTH

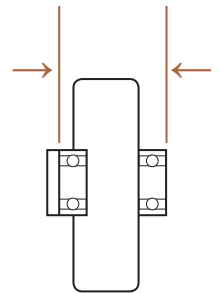

MOUNTING WIDTH



## PALLET TRUCK WHEELS

### Nylon Steer Wheels

Picture				
Wheel Material	Nylon	Nylon	Nylon	Nylon
Wheel Diameter	150mm	160mm	175mm	200mm
Tread Width	40mm	50mm	50mm	50mm
Bore	17mm	20mm	20mm	20mm
Hub Length	40mm	50mm	50mm	50mm
Mounting Width	40mm	44mm	43mm	43mm
Bearings	6203	6204	6204	6204
Carrying Capacity	550kg	600kg	630kg	730kg
Suits Models	KI 500	MA10	MA15, MA25/75, MA30/75	DF25, MA20, MA25, MA30, MA35
Part Number	ST-NY01	ST-NY02	ST-NY03	ST-NY04
Price	£24.00	£24.00	£20.00	£22.00

### Nylon Steer Wheels

### Polyurethane Steer Wheels

Picture				
Wheel Material	Nylon	Red Polyurethane on Cast Iron	Red Polyurethane on Cast Iron	Red Polyurethane on Cast Iron
Wheel Diameter	200mm	125mm	180mm	200mm
Tread Width	50mm	38mm	50mm	50mm
Bore	20mm	17mm	20mm	20mm
Hub Length	60mm	38mm	50mm	50mm
Mounting Width	54mm	38mm	43mm	43mm
Bearings	6204	6203	6204	6204
Carrying Capacity	730kg	450kg	750kg	750kg
Suits Models	LLT23, LLT30	LLT500	MA20/75, MA25/75	DF25, MA20, MA25, MA30
Part Number	ST-NY05	ST-PU01	ST-PU02	ST-PU03
Price	£24.00	£22.00	£24.00	£26.00

### Polyurethane Steer Wheels

Picture				
Wheel Material	Yellow Polyurethane on Cast Iron	Light Brown Polyurethane on Alloy	Polyurethane on Iron	Polyurethane on Iron
Wheel Diameter	200mm	200mm	200mm	200mm
Tread Width	50mm	50mm	50mm	50mm
Bore	20mm	20mm	30mm	20mm
Hub Length	50mm	60mm	50mm	60mm
Mounting Width	47mm	54mm	50mm	43mm
Bearings	6204	6204	6006	6304
Carrying Capacity	1000kg	750kg	1500kg	1500kg
Suits Models	PT20, PT25, PTA22	LLT23, LLT30	MA50	LLT40, LLT50
Part Number	ST-PU04	ST-PU05	ST-PU06	ST-PU07
Price	£28.00	£26.00	£182.00	£176.00

**PALLET TRUCK WHEELS**

**Rubber Steer Wheels**

Picture			
Wheel Material	Black Rubber on alloy	Black Rubber on alloy	White Rubber on alloy
Wheel Diameter	180mm	200mm	200mm
Tread Width	50mm	50mm	50mm
Bore	20mm	20mm	20mm
Hub Length	50mm	50mm	50mm
Mounting Width	44mm	44mm	44mm
Bearings	6204	6204	6204
Carrying Capacity	600kg	650kg	650kg
Suits Models	MA25/75, MAWS	DF25, MA20, MA25	DF25, MA20, MA25
Part Number	ST-RU01	ST-RU02	ST-RU03
Price	£24.00	£26.00	£28.00

**Metal Steer Wheels**

Picture				
Wheel Material	Steel	Steel	Steel	Grey Antistatic Polyurethane
Wheel Diameter	180mm	200mm	200mm	82mm
Tread Width	50mm	50mm	50mm	90mm
Bore	20mm	20mm	30mm	20mm
Hub Length	54mm	54mm	54mm	90mm
Mounting Width	44mm	44mm	52mm	90mm
Bearings	6204	6204	6206	6204
Carrying Capacity	1000kg	1100kg	1300kg	750kg
Suits Models	DF25, MA20, MA25, MA30, MA35, LLT23, LLT30	DF25, MA20, MA25, MA30, MA35, LLT23, LLT30	MA50	DF25, MA20, MA25, MA30, MA35, LLT23, LLT30
Part Number	ST-SL01	ST-SL02	ST-SL03	LD-AS05
Price	£98.000	£108.00	£108.00	£50.00

**Antistatic Single Roller**

**Antistatic Steer & Load Wheels**

Picture				
Wheel Material	Antistatic Nylon	Antistatic Rubber on alloy	Antistatic Polyurethane on Alloy	Grey Antistatic Polyurethane
Type	Steer Wheel	Steer Wheel	Steer Wheel	Tandem Load Wheel
Wheel Diameter	200mm	200mm	200mm	82mm
Tread Width	50mm	50mm	50mm	70mm
Bore	20mm	20mm	20mm	20mm
Hub Length	60mm	60mm	50mm	70mm
Mounting Width	54mm	54mm	44mm	70mm
Bearings	6204	6204	6204	6204
Carrying Capacity	730kg	650kg	700kg	550kg
Suits Models	LLT23, LLT30	LLT23, LLT30	DF25, MA20, MA25, MA30, MA35	DF25, MA20, MA25, MA30, MA35, LLT23, LLT30
Part Number	ST-AS01	ST-AS02	ST-AS03	LD-AS04
Price	£60.00	£100.00	£120.00	£44.00

## PALLET TRUCK WHEELS

### Nylon Load Wheels

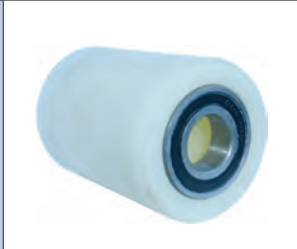
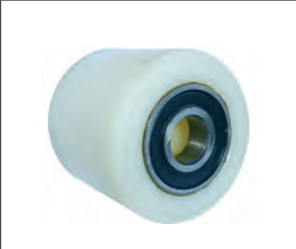
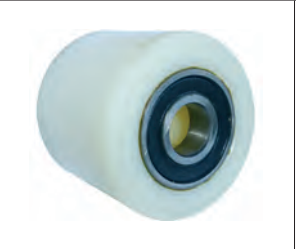
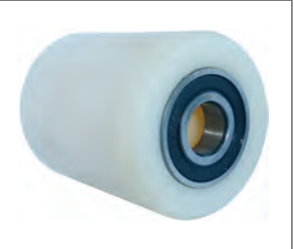
Picture				
Wheel Material	Nylon	Nylon	Nylon	Nylon
Type	Tandem	Single	Tandem	Single
Wheel Diameter	50mm	58mm	74mm	74mm
Tread Width	70mm	54mm	70mm	93mm
Bore	17mm	17mm	20mm	20mm
Hub Length	70mm	54mm	70mm	93mm
Mounting Width	70mm	54mm	70mm	93mm
Bearings	6003	6203	6204	6204
Carrying Capacity	350kg	300kg	600kg	850kg
Suits Models	MA15	LLT500	MA25/75, MA30/75	MA25/75, MA30/75
Part Number	LD-NY01	LD-NY02	LD-NY03	LD-NY04
Price	£16.00	£15.00	£14.00	£16.00

Picture				
Wheel Material	Nylon	Nylon	Nylon	Nylon
Type	Tandem	Tandem	Single	Single
Wheel Diameter	82mm	82mm	82mm	82mm
Tread Width	60mm	70mm	90mm	93mm
Bore	20mm	20mm	20mm	20mm
Hub Length	60mm	70mm	90mm	93mm
Mounting Width	60mm	70mm	90mm	93mm
Bearings	6204	6204	6204	6204
Carrying Capacity	650kg	700kg	900kg	900kg
Suits Models	PTA, PT	DF25, MA20, MA25, MA30, MA35 LLT23, LLT30	Various	DF25, MA25/85, MA30
Part Number	LD-NY05	LD-NY06	LD-NY07	LD-NY08
Price	£14.00	£14.00	£14.00	£16.00

Picture			
Wheel Material	Nylon	Nylon	Nylon
Type	Single	Single	Single
Wheel Diameter	82mm	82mm	82mm
Tread Width	95mm	98mm	100mm
Bore	20mm	20mm	20mm
Hub Length	95mm	98mm	100mm
Mounting Width	95mm	98mm	100mm
Bearings	6204	6204	6204
Carrying Capacity	900kg	1000kg	1000kg
Suits Models	Various	BT, LLT23	LLT23
Part Number	LD-NY09	LD-NY10	LD-NY11
Price	£16.00	£16.00	£16.00

## PALLET TRUCK WHEELS

### Polyurethane Load Wheels

Picture				
Wheel Material	Light Brown Polyurethane on Steel	Light Brown Polyurethane on Steel	Red Polyurethane on Steel	Red Polyurethane on Steel
Type	Tandem	Single	Tandem	Single
Wheel Diameter	50mm	58mm	74mm	74mm
Tread Width	70mm	50mm	70mm	93mm
Bore	17mm	17mm	20mm	20mm
Hub Length	70mm	50mm	70mm	93mm
Mounting Width	68mm	50mm	70mm	93mm
Bearings	6003	6203	6204	6204
Carrying Capacity	400kg	300kg	500kg	800kg
Suits Models	MA15 LLT23/51	LLT500	MA25/75, MA30/75, MAWS	MA25/75, MA30/75, MAWS
Part Number	LD-PU01	LD-PU02	LD-PU03	LD-PU04
Price	£24.00	£24.00	£22.00	£24.00





Picture				
Wheel Material	Yellow Polyurethane on Steel	Black Polyurethane on Steel	Red Polyurethane on Steel	Red Polyurethane on Steel
Type	Single	Tandem	Tandem	Single
Wheel Diameter	76mm	80mm	80mm	80mm
Tread Width	85mm	58mm	70mm	93mm
Bore	20mm	20mm	20mm	20mm
Hub Length	85mm	58mm	70mm	93mm
Mounting Width	85mm	58mm	70mm	93mm
Bearings	6204	6204	6204	6204
Carrying Capacity	850kg	600kg	550kg	850kg
Suits Models	PT20, PT25, PTA22	PT20, PT25, PTA22	DF25, MA20, MA25, MA30, MA35 LLT23, LLT30	DF25, MA20, MA25, MA30, MA35 LLT23, LLT30
Part Number	LD-PU05	LD-PU06	LD-PU07	LD-PU08
Price	£26.00	£24.00	£22.00	£26.00

Picture				
Wheel Material	Light Brown Polyurethane on Steel	Light Brown Polyurethane on Steel	Light Brown Polyurethane on Steel	Light Brown Polyurethane on Steel
Type	Tandem	Tandem	Single	Single
Wheel Diameter	82mm	82mm	82mm	82mm
Tread Width	60mm	70mm	90mm	95mm
Bore	20mm	20mm	20mm	20mm
Hub Length	60mm	70mm	90mm	95mm
Mounting Width	60mm	70mm	90mm	95mm
Bearings	6204	6204	6204	6204
Carrying Capacity	400kg	500kg	550kg	600kg
Suits Models	Various	LLT23, LLT30	Various	Various
Part Number	LD-PU09	LD-PU10	LD-PU11	LD-PU12
Price	£24.00	£24.00	£26.00	£28.00

More polyurethane load wheels on the next page

## PALLET TRUCK WHEELS

### Polyurethane Load Wheels

Picture				
Wheel Material	Light Brown Polyurethane on Steel	Light Brown Polyurethane on Steel	Brown Polyurethane on Steel	Light Brown Polyurethane on Steel
Type	Single	Single	Tandem	Tandem
Wheel Diameter	82mm	82mm	85mm	85mm
Tread Width	98mm	100mm	70mm	80mm
Bore	20mm	20mm	20mm	20mm
Hub Length	98mm	100mm	70mm	80mm
Mounting Width	98mm	100mm	70mm	80mm
Bearings	6204	6204	4204	6204
Carrying Capacity	900kg	900kg	1000kg	1000kg
Suits Models	BT, LLT23, LLT30	LLT23, LLT30	MA50	Various
Part Number	LD-PU13	LD-PU14	LD-PU15	LD-PU16
Price	£26.00	£28.00	£62.00	£36.00

### Rubber Load Wheels

Picture				
Wheel Material	White Rubber on Steel	Black Rubber on Steel	Black Rubber on Steel	White Rubber on Steel
Type	Tandem	Tandem	Single	Single
Wheel Diameter	82mm	82mm	82mm	82mm
Tread Width	70mm	70mm	90mm	100mm
Bore	20mm	20mm	20mm	20mm
Hub Length	70mm	70mm	90mm	100mm
Mounting Width	70mm	70mm	90mm	100mm
Bearings	6204	6204	6204	6204
Carrying Capacity	400kg	400kg	450kg	450kg
Suits Models	DF25, MA20, MA25, LLT23	DF25, MA20, MA25, LLT23	DF25, MA20, MA25, LLT23	LLT23
Part Number	LD-RU01W	LD-RU01B	LD-RU02	LD-RU03
Price	£26.00	£26.00	£28.00	£32.00

### Rubber Load Wheel

### Metal Load Wheels

Picture				
Wheel Material	Black Rubber on Steel	Steel	Steel	Steel
Type	Single	Tandem	Tandem	Single
Wheel Diameter	85mm	34mm	80mm	80mm
Tread Width	100mm	58mm	70mm	93mm
Bore	20mm	12mm	20mm	20mm
Hub Length	90mm	58mm	70mm	92mm
Mounting Width	90mm	Axle 80mm	70mm	92mm
Bearings	6204	Ball bearing	6204	6204
Carrying Capacity	500kg	400kg	1000kg	1200kg
Suits Models	LLT23, F8RL	MA10/35	DF25, MA20, MA25, MA30, MA35 LLT23, LLT30	DF25, MA20, MA25, MA30, MA35 LLT23, LLT30
Part Number	LD-RU04	LD-SL01	LD-SL02	LD-SL03
Price	£30.00	£36.00	£38.00	£44.00



## SACK TRUCK WHEELS

### Sack Truck Wheels

Picture				
Wheel Material	Solid Rubber on Nylon	Pneumatic on Steel	Solid Rubber on Steel	Pneumatic on Steel
Type	WI	CO	CO	CO
Wheel Diameter	200mm	200mm	260mm	260mm
Tread Width	50mm	50mm	60mm	65mm
Bore	20mm	20mm	20mm	20mm
Hub Length	54mm	56mm	75mm	75mm
Mounting Width	54mm	56mm	75mm	75mm
Bearings	Roller	Roller	Roller	Roller
Carrying Capacity	200kg	70kg	150kg	150kg
Suits Models	403/KI, 404/KI	428/CS	most CO/KI	most CO/KI
Part Number	SK-RU01	SK-PN01	SK-RU02	SK-PN02
Price	£15.00	£28.00	£22.00	£24.00

Picture				
Wheel Material	Pneumatic on Nylon	Pneumatic on Steel	Puncture Proof on Steel	Puncture Proof on Steel, square
Type	CO	KI	CO	KI
Wheel Diameter	260mm	260mm	260mm	260mm
Tread Width	65mm	65mm	65mm	70mm
Bore	20mm	20mm	20mm	20mm
Hub Length	75mm	75mm	75mm	70mm
Mounting Width	75mm	75mm	75mm	70mm
Bearings	Roller	Ball	Roller	Ball
Carrying Capacity	130kg	130kg	130kg	130kg
Suits Models	most CO/KI	most CO/KI	most CO/KI	most CO/KI
Part Number	SK-PN03	SK-PN04	SK-PP01	SK-PP02
Price	£22.00	£20.00	£28.00	£22.00

Picture				
Wheel Material	Puncture proof on Steel, ex-centric, square	Pneumatic on Steel, ex-centric	Puncture proof on Steel, ex-centric, square	Pneumatic on Steel
Type	KI	KI	KI	CO
Wheel Diameter	260mm	260mm	260mm	300mm
Tread Width	70mm	60mm	70mm	80mm
Bore	20mm	16mm	16mm	20mm
Hub Length	75mm	50mm	48mm	75mm
Mounting Width	75mm	50mm	48mm	75mm
Bearings	Ball	Ball	Ball	Roller
Carrying Capacity	130kg	130kg	130kg	245kg
Suits Models	most CO/KI	435/KI, 436/KI	435/KI, 436/KI	416/CO
Part Number	SK-PP04	SK-PN06	SK-PP05	SK-PN07
Price	£22.00	£22.00	£22.00	£34.00

More sack truck wheels on the next page

## SACK TRUCK WHEELS

### Sack Truck Wheels

Picture				
Wheel Material	Pneumatic on Steel	Puncture Proof on Steel, round	Polyurethane Foam (Puncture proof)	Foam Filled (Puncture proof)
Type	CO	CO	PC	PC
Wheel Diameter	300mm	300mm	200mm	200mm
Tread Width	80mm	70mm	50mm	50mm
Bore	20mm	20mm	20mm	20mm
Hub Length	75mm	75mm	60mm	60mm
Mounting Width	75mm	75mm	60mm	60mm
Bearings	Ball	Roller	Roller	Roller
Carrying Capacity	225kg	200kg	100kg	150kg
Suits Models	416/CO	416/CO	403/KI, 404/KI, 428/CS, Film carts, 200mm Castors	403/KI, 404/KI, 428/CS, Film carts, 200mm Castors
Part Number	SK-PN08	SK-PP06	SK-PP07	SK-PP08
Price	£38.00	£44.00	£25.00	£54.00

## WHEEL ACCESSORY PARTS

### Individual Bearings

BEARINGS	PRICE
6204, 20 x 47mm	£2.60
6205, 25 x 52mm	£3.00
6302, 15 x 42mm	£3.00
6303, 17 x 47mm	£3.00
6304, 20 x 52mm	£3.00
6005, 25 x 47mm	£3.00
6204 stainless steel	£8.60
6205 stainless steel	£10.00
6304 stainless steel	£10.00
R10ZZ, 16 x 35mm (sack truck bearing)	£4.60



### Axle Caps

INTERNAL DIAMETER	PRICE
20mm	£1.50
25mm	£1.80



### Split Pin

DIAMETER x LENGTH	PRICE
3 x 25mm	95p



### Washers

INTERNAL DIAMETER x THICKNESS	PRICE
21 x 2mm	95p
26 x 4mm	£1.00



### Circlips

INTERNAL DIAMETER	PRICE
20mm	£1.45
25mm	£1.55



# Product Index

## F

### Furniture & Machinery Movers

Furniture & Equipment Mover Set	44
Hydraulic Furniture Mover Set	44
Mechanical Furniture Mover Jack	44
Roller Crowbar	44

## H

### High Lift Pallet Trucks

Electric High Lift Pallet Trucks	32
Manual High Lift Pallet Trucks	32
Stainless Steel High Lift Pallet Truck	32

## J

### Jacks

50t Jack	39
Forklift Jack	39
Hydraulic Toe Jack	38
Machinery Toe Jack	38
Rotational Hydraulic Toe Jack	39
Stainless Steel Jack	39

## M

### Magliner Hand Trucks

Accessories	72
Accessory Bags	72
Bottled Water Tray Trucks	64
Castor Dollies	69
Complete Hand Trucks	61-63
Folding Nose Kit	72
Folding Noses	72
Hand Truck Frames	70
Hand Truck Handles	70
Hand Truck Noses	71
Hand Truck Wheels	71
Hi-U Frame Extensions	72
Keg Hook	72
Kerb Ramp	69
Narrow Aisle Hand Trucks	64
Paddle Brakes	72
Platform Castors	69
Platform Trucks	69
Self-Stabilising Hand Trucks	66
Six Wheel Platform Truck	68
Space Saving Folding Trucks	65
Stair Climber	72
Three Position Hand Truck	68
Two Position Hand Truck	67
Wheel Guards	72

## P

### Pallet Tilters

Electric Pallet Tilter	33
Manual Pallet Tilter	33
Straddle Pallet Tilter	33

### Pallet Trucks

4-Way Hand Pallet Trucks	10
Adjustable Pallet Truck	5
Atex Pallet Trucks	11
Electric Pallet Trucks	14-16
Extra Long Pallet Trucks	2, 5, 6
Galvanised Pallet Trucks	8
Heavy Duty Pallet Trucks	2, 5, 7, 17
Higher Lift Pallet Trucks	10
Low Profile Pallet Trucks	4, 7
Mini Pallet Truck	4
Narrow Printer's Pallet Trucks	3
Pallet Truck Chocks	3
Pallet Truck Options	2, 3, 6
Powered Pallet Trucks	16, 17
Premium Hand Pallet Trucks	6, 7
Reel Carrying Pallet Trucks	11
Rough terrain Pallet Stackers	15
Rough Terrain Pallet Trucks	12-14
Stainless Steel Pallet Trucks	8
Standard Pallet Trucks	2
Very Heavy Duty Pallet Trucks	5, 7, 17
Weighing Pallet Trucks	9

### Platform Trolleys

Aluminium Platform Trolleys	46-47
Cash & Carry Trolleys	49
Folding Handles	46-47
Folding Platform Trolleys	47
Garden Truck with Fold Down Sides	48
Fold-It Collapsible Aluminium Cart	58
Heavy Duty Platform Trolleys	48
Large Platform Trolleys	46
Three Tier Trolley	47
Two Tier Trolley	47

## S

### Sack Trucks

Aluminium Folding Sack Trucks	54
Beer Keg Truck	52, 54
Curved Back Sack Trucks	51, 52, 54
Folding Footplate Sack Trucks	53, 54
Heavy Duty Sack Trucks	50, 51, 53
High Back Sack Trucks	52

Kerb Ramp	55
Load Retention Straps	55
P-Shaped Handle Sack Trucks	51
Rough Terrain Sack Trucks	50
Ruxxac Hand Trucks	56-57
Sack Trucks with Skids	50-53
Stair Climber Sack Trucks	54
Three-Way Sack Trucks	53
Universal Sack Trucks	50

### Scissor Lift Tables

Aluminium Scissor Lift Tables	36
Double Scissor Lift Tables	34-35
Electric Scissor Lift Tables	35, 37
Low Profile Scissor Lifts	37
Manual Scissor Lift Tables	34, 36
Scissor Lift Table Attachments	35
Single Scissor Lift Tables	34, 36
Stainless Steel Scissor Lift Tables	36

### Skates

Adjustable Skate Pairs	41
Caterpillar Skate Kit	43
Corner Skate Set	43
Individual Skates	40-41
Skate Sets	42
Skates with Swivel Castors	40-41
Steerable Skates	42

### Skid Lifters

33

### Stackers & Lifters

Accessories & Options	25
Adjustable Forks	20-23
Counterbalanced Stackers	29
Electric Lift Pallet Stackers	24-25
Electric Mini Stackers	19
Electric Stackers	20, 24-25
Heavy Duty Pallet Stackers	23, 25, 28-29
Manual Pallet Stackers	20-23
Powered Pallet Stackers	26-29
Special Stackers	25, 30-31
Straddle Pallet Stackers	21-28
Winch Lifters	18, 19

## W

### Wheels

Pallet Truck Steer Wheels	74-75
Pallet Truck Load Wheels	75-78
Sack Truck Wheels	79-80
Wheel Accessory Parts	80

### Workshop Cranes

45

